



# 2022 PRODUCT CATALOG



**QUALITY PRODUCTS YOU CAN TRUST**

# OUR NEVER-SATISFIED APPROACH COMBINED WITH A CUSTOMER-FIRST PHILOSOPHY IS THE FOUNDATION FOR OUR EVER-GROWING BRAND.

Alpine Industries is a New Jersey-based manufacturer of food service and janitorial products for commercial and institutional markets worldwide. Our company believes that quality products do not need to be expensive. Since our inception in 2015, we now have a wide range of innovative products known for their advanced technologies, space-saving design, and affordability. This powerful trio makes us a leading provider of bathroom accessories, restaurant supplies, waste receptacles, and safety products.

We seek to grow our businesses with our existing customers and develop new partnerships in various markets. Our goal is to expand and make a positive difference in commercial businesses in North America and beyond. In line with this, we are looking for reputable, agile distributors who can partner with us. We would love to set up a time to discuss this opportunity with you. With the combination of Alpine Industries' marketable line of products and reliable customer support, as well as your proven market knowledge and resources, we are optimistic that our partnership will bring both our businesses to new heights.

**Join us, and let's achieve great things together!**



---

# PRODUCT CATEGORIES



**02** Trash Cans,  
Recycling Stations  
and Receptacles

---



**13** Washroom/  
Restroom Accessories

---



**30** Janitorial and  
Cleaning Supplies

---



**42** Odor Control  
Supplies

---



**45** Business /  
Restaurant Signage

---



**54** Water  
Fountain

---



**56** Restaurant Furniture  
and Supplies

---

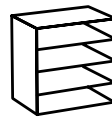

**60** Storage  
and Shelving

---



**72** Furniture

---



**78** Office Furniture

---



**91** Office  
Supplies

---



# TRASH CANS, RECYCLING STATIONS AND RECEPTACLES

## SUBCATEGORIES

Outdoor Trash Cans .....	03
Trash Cans .....	08
Indoor Decorative Trash Cans .....	10
Trash Can Accessories .....	11
Recycling Stations .....	12
Cigarette Receptacles .....	12



**OUTDOOR  
DECORATIVE PLASTIC TRASH CANS**

- Domed top keeps rain out
- Opens easily to remove trash
- Round base for stability
- Suitable for both indoor and outdoor use

**DIMENSIONS:** 30.4" x 14.4" x 14.4"

**CAPACITY:** 16 Gallon

**CASE QUANTITY:** 1

**UNIT OF MEASURE:** Each

ITEM#	FINISH	ASHTRAY LID
ALP474-16	Black Panel	No
ALP474-16-AU	Black Panel	Yes

**AVAILABLE WITH OR  
WITHOUT ASHTRAY LID**

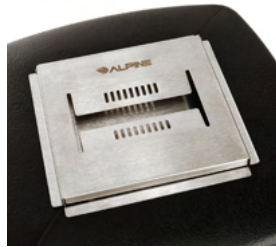

**ASHTRAY OPTION**



**WIDE OPENING**



**REMOVABLE LID**



**38 Gallon****OUTDOOR METAL WASTE & RECYCLING RECEPTACLES**

- Constructed with reinforced circular bands and rolled edges to ensure its longevity
- The 38-gallon holding capability requires less emptying by maintenance workers
- Its polyester powder coating provides a polished finish and deters vandals

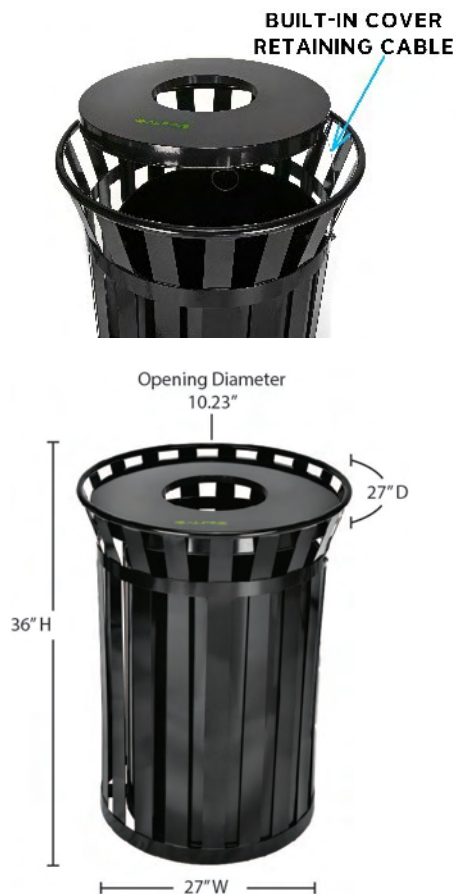
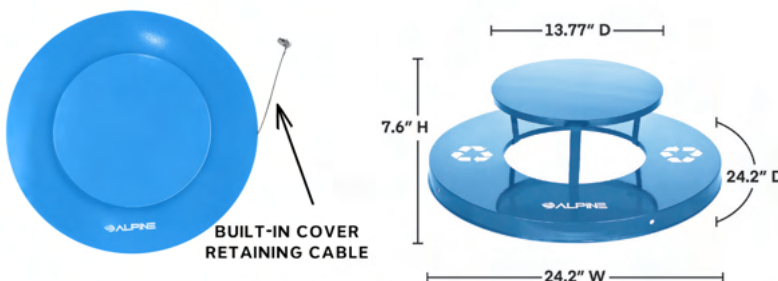
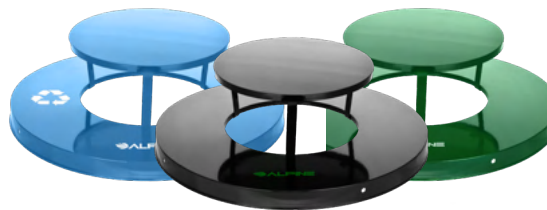
**ITEM #:** ALP479-38-SERIES**DIMENSIONS:** 36" x 26.7" x 21"**CASE QUANTITY:** 1**UNIT OF MEASURE:** Each**38 Gallon****RAIN BONNET LID FOR OUTDOOR METAL WASTE & RECYCLING RECEPTACLES****ITEM #:** ALP479-38-A-SERIES**DIMENSIONS:** 7.6" x 24.2" x 24.2"**CASE QUANTITY:** 1**UNIT OF MEASURE:** Each

- Designed to stop snow and rain from flooding your waste receptacles
- Elevated lid keeps rain and snow out of the receptacle
- Fully welded lid holds up to all weather conditions



**38 Gallon**

**OUTDOOR METAL WASTE & RECYCLING RECEPTACLES WITH RAIN BONNET LID**



**ITEM #:** ALP479-38-1-SERIES  
**DIMENSIONS:** 43.6" x 26.7" x 21"  
**CASE QUANTITY:** 1  
**UNIT OF MEASURE:** Each

- Constructed with reinforced circular bands and rolled edges to ensure its longevity
- 38-gallon holding capability requires less emptying by maintenance workers
- Its polyester powder coating that provides a polished finish and deters vandals
- Included Rain Bonnet prevents snow and rain from flooding your receptacle



ITEM#	PRODUCT NAME	COLOR	WEIGHT	DIMENSIONS
ALP479-38-BLK	38 Gallon, Outdoor Waste Receptacle	Black	59.9 lbs.	36" x 27" x 27"
ALP479-38-A-BLK	38 Gallon, Rain Bonnet Lid	Black	15 lbs.	7.6" x 24.2" x 24.2"
ALP479-38-1-BLK	38 Gallon, Outdoor Waste Receptacle with Rain Bonnet	Black	74.9 lbs.	40.66" x 27" x 27"
ALP479-38-GRN	38 Gallon, Outdoor Waste Receptacle	Green	59.9 lbs.	36" x 27" x 27"
ALP479-38-A-GRN	38 Gallon, Rain Bonnet Lid	Green	15 lbs.	7.6" x 24.2" x 24.2"
ALP479-38-1-GRN	38 Gallon, Outdoor Waste Receptacle with Rain Bonnet	Green	74.9 lbs.	40.66" x 27" x 27"
ALP479-38-BLU	38 Gallon, Outdoor Recycling Receptacle	Blue	59.9 lbs.	36" x 27" x 27"
ALP479-38-A-BLU	38 Gallon, Rain Bonnet Lid	Blue	15 lbs.	7.6" x 24.2" x 24.2"
ALP479-38-1-BLU	38 Gallon, Outdoor Waste Receptacle with Rain Bonnet	Blue	74.9 lbs.	40.66" x 27" x 27"

**INCLUDED WITH THE ALP479-38-SERIES & ALP479-38-1-SERIES:**

- Metal liner
- Bolts to secure it in place



INCLUDED  
HARDWARE TO  
BOLT INTO  
PLACE.



## DHS-COMPLIANT WASTE RECEPTACLE WITH TRANSPARENT PANELS

- Each trash container has adjustable legs to ensure stability and support
- The substantially sized 40-gallon receptacle will require less emptying
- Secure locking lid reduces pilferage and vandalism
- For indoor and outdoor use

**ITEM #:** ALP471-40-CLR

**DIMENSIONS:** 41.33" x 21.25" x 21.25"

**CASE QUANTITY:** 1

**UNIT OF MEASURE:** Each



Affixed interior metal clips prevent trash bags from slipping.



Included key securely locks the lid when service has been completed.



Clear, DHS-compliant panels will inhibit planting hazardous devices.





## RUGGED 40-GALLON ALL-WEATHER TRASH CONTAINERS

- Domed top keeps rain out
- Includes removeable leakproof trash liner and key
- Lockable lid reduces tampering and pilferage
- Available with or without an ashtray

**DIMENSIONS:** 41.3" x 21" x 21"

**CAPACITY:** 40 Gallon

**CASE QUANTITY:** 1

**UNIT OF MEASURE:** Each



STAINLESS-STEEL  
ASHTRAY

REPLACEMENT KEY  
2 PACK  
ITEM#: ALP471-40-KEY  
CASE QUANTITY: 1  
UNIT OF MEASURE: EACH

ITEM#	FINISH		ASHTRAY
ALP471-40-STO	Stone Panel		No
ALP471-40-SIL	Silver Panel		No
ALP471-40-GRY	Gray Stone Panel		No
ALP472-40-STO	Stone Panel		Yes
ALP472-40-SIL	Silver Panel		Yes
ALP472-40-GRY	Gray Stone Panel		Yes

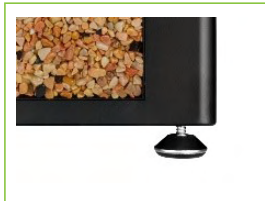

ADJUSTABLE LEGS



EQUIPPED LOCK



CHAIN LINKED  
SECURITY CHAINS



SLOTTED BOTTOM



PLASTIC TRASH LINER



## SLIM TRASH CAN / RECYCLE BIN

- Space-saving shape for tight areas
- Tough plastic will not crack or dent
- Suitable for indoor or outdoor use

**DIMENSIONS:** 30" x 20" x 11"

**CAPACITY:** 23 Gallon







**CASE QUANTITY:** 1

**UNIT OF MEASURE:** Each

ITEM#	FINISH	
ALP477-GRY	Gray	
ALP477-BLK	Black	
ALP477-R-BLU	Blue	
ALP477-LGRN	LimeGreen	
ALP477-GRN	Green	

## LIDS FOR SLIM TRASH CAN/RECYCLING BIN

- Conceals unattractive waste and reduces unpleasant trash can odors
- Suitable for indoor or outdoor use

ITEM#	FINISH		LID TYPE	DIMENSIONS	CASE QTY.
ALP478-1-LGRN	LimeGreen		Swing Dome	6.3" x 20" x 12"	10
ALP478-1-GRN	Green		Swing Dome	6.3" x 20" x 12"	10
ALP478-2-BLK	Black		Drop Shot	5" x 20" x 12"	8
ALP478-2-BLU	Blue		Drop Shot	5" x 20" x 12"	8
ALP478-3-GRN	Green		Can/Bottle Recycling	2.9" x 20" x 12"	20
ALP478-4-BLU	Blue		Recycling Paper	2.9" x 20" x 12"	20
ALP478-4-GRN	Green		Recycling Paper	2.9" x 20" x 12"	20



**WOOD TRAY TOP**

**WASTE ENCLOSURE TRASH CAN RECEPTACLE**

- Swing open door has a thank you message and hinges
- Open bottom door to insert large capacity waste basket liner (sold separately)
- Top tray area 22" x 21" for holding large amounts of cafeteria trays
- Ships disassembled



**CAPACITY:** 40 Gallon  
**CASE QUANTITY:** 1  
**UNIT OF MEASURE:** Each

ITEM#	FINISH	
ALP476-WHI	White	
ALP476-MEO	Medium Oak	
ALP476-BLK	Black	



**LARGE INTERIOR**

**WIDE OPENING**

**LIPPED-TOP**

**40 GALLON PLASTIC LINERS**



**ITEM#** ALPPLA01  
**COLOR:** Black  
**CASE QUANTITY:** 1  
**UNIT OF MEASURE:** Each





LIFT-OFF LID

WIDE OPENING

## HEAVY-DUTY STAINLESS STEEL DECORATIVE TRASH CAN

- Easy disposal, no cover to touch or move out of the way
- Lift off lid that conceals trash bags
- Durable and long-lasting stainless steel trash can
- Open top eliminates surface contact

**CASE QUANTITY:** 1

**UNIT OF MEASURE:** Each

ITEM#	CAPACITY	DIMENSIONS
ALP475-50	50 Gallon	35" x 24" x 24"
ALP475-27	27 Gallon	32" x 16" x 16"



**27**  
gallon



**50**  
gallon



OPEN TOP

SWING LID

## STAINLESS STEEL DECORATIVE TRASH CAN

- Side handles for easy transportation
- Smudge-resistant brushed stainless steel
- Black ring to hold trash bags firmly in place
- Lift-off lid for easy bag change

**DIMENSIONS:** 27.1" x 16.5" x 15.7"

**CAPACITY:** 17 Gallon

**CASE QUANTITY:** 1

**UNIT OF MEASURE:** Each

ITEM#	LID TYPE
ALP470-65L	Open Top Can
ALP470-65L-1	Swing Lid



## SWING LID FOR ALP470-65L-SERIES

**ITEM #:** ALP470-65L-C

**DIMENSIONS:** 3.34" x 15.67" x 15.67"

**CASE QUANTITY:** 1

**UNIT OF MEASURE:** Each



**RECTANGULAR  
OPEN TOP STAINLESS  
STEEL TRASH CAN**

- Smudge-resistant brushed stainless steel
- Includes removable rigid plastic liner
- Space-saving design
- Wide open top for quick and easy trash disposal

UP TO  
**10.5**  
GALLON

**ITEM #:** ALP470-40L  
**FINISH:** Stainless Steel  
**CASE QUANTITY:** 1  
**UNIT OF MEASURE:** Each

ITEM#	CAPACITY	DIMENSIONS
ALP470-10L	2.7 Gallon	13" x 11" x 7.6"
ALP470-20L	5.2 Gallon	17" x 14" x 8.9"
ALP470-40L	10.5 Gallon	25" x 17" x 10"
ALP470-R-40L	10.5 Gallon	25" x 17" x 10"



**DUAL COMPARTMENT,  
RECTANGULAR  
OPEN TOP  
STAINLESS STEEL  
TRASH CAN**

- Dual compartments offer convenient waste separation
- Smudge-resistant brushed stainless steel
- Includes removable rigid plastic liner
- Wide open top for quick and easy trash disposal

**ITEM #:** ALP470-R-40L  
**FINISH:** Stainless Steel  
**CASE QUANTITY:** 1  
**UNIT OF MEASURE:** Each

TRASH CANS, RECYCLING BINS, AND RECEPTACLES / TRASH CAN ACCESSORIES



**CADDY BAG  
FOR ROUND AND SQUARE  
TRASH CANS**

**ITEM #:** ALP4777-1  
**DIMENSIONS:** 19.5" x 29"

**CASE QUANTITY:** 25  
**UNIT OF MEASURE:** Each



**SLIM  
TRASH CAN  
DOLLY**



- Designed for use with 16 / 23 gallon slim trash cans and recycle bins
- Can be attached to another dolly
- Heavy-duty plastic construction
- Sturdy, non-marking, 3" rubber casters

**ITEM #:** ALP477-DOLLY  
**DIMENSIONS:** 8.2" x 24.4" x 15.7"  
**CASE QUANTITY:** 5  
**UNIT OF MEASURE:** Each

**ROUND  
TRASH CAN  
DOLLY**



- Fits 20, 32, 44, and 55 gallon trash cans
- 350 lb. weight capacity
- Sturdy, non-marking, 3" rubber casters

**ITEM #:** ALP471-32-DOLLY  
**DIMENSIONS:** 6.1" x 17.91" x 17.91"  
**CASE QUANTITY:** 5  
**UNIT OF MEASURE:** Each



## CORRUGATED PLASTIC RECYCLING STATION

- Lightweight and portable
- Decals included: Glass, Plastic, Paper, Recyclables, Cans, and Waste
- 12-inch round deposit opening
- Ships disassembled

**FINISH:** Corrugated plastic

**CAPACITY:** 28 Gallons Per Bin

**CASE QUANTITY:** 1

**UNIT OF MEASURE:** Each

ITEM#	# OF BINS	DIMENSIONS
ALP471-02-BLK	2	32.5" x 31" x 16"
ALP471-03-BLK	3	32.5" x 46" x 16"

## TRASH CANS, RECYCLING BINS, AND RECEPTACLES / CIGARETTE RECEPTACLES

### WALL-MOUNTED

### CIGARETTE DISPOSAL STATION

- Weather and fire-resistant steel
- Includes removable rigid metal liner
- Space-saving design

ITEM#	FINISH		DIMENSIONS	CASE QTY.
ALP490-01-BLK	Black		12.5" x 10.2" x 3.2"	10
ALP490-01-SS	Stainless Steel		12.5" x 10.2" x 3.2"	10
ALP490-02-BLK	Black		12.2" x 5.8" x 4.2"	8
ALP490-02-SS	Stainless Steel		12.2" x 5.8" x 4.2"	8
ALP490-03-BLK	Black		12.2" x 5.5" x 2.3"	10
ALP490-03-SS	Stainless Steel		12.2" x 5.5" x 2.3"	10

#### 490-01-SERIES



#### 490-02-SERIES



#### 490-03-SERIES





# WASHROOM / RESTROOM ACCESSORIES

## SUBCATEGORIES

Hand Dryers and Accessories .....	14
Baby Changing Stations .....	16
Paper Towel Dispensers/holders .....	18
Tissue Box Holders .....	21
Tissue Dispensers .....	22
Soap/Sanitizer Dispensers .....	24
Sanitary Napkin Receptacles .....	27
Grab Bars .....	27
Toilet Seat Covers and Dispensers .....	28



## HEMLOCK HIGH-SPEED ELECTRIC HAND DRYER

- 10 second drying time
- Can be hard-wired or plugged in for quick installation
- 5-year limited warranty

BRUSHED STAINLESS  
STEEL

**DIMENSIONS:** 12.6" x 11.25" x 6.5"

**CASE QUANTITY:** 2

**UNIT OF MEASURE:** Each

ITEM#	FINISH		VOLTAGE
ALP400-10-BLA	Black		110V
ALP400-10-CHR	Chrome		110V
ALP400-10-COP	Coffee		110V
ALP400-10-GRY	Gray		110V
ALP400-10-RED	Red		110V
ALP400-10-WHI	White		110V
ALP400-10-SSB	Brushed Stainless Steel		110V
ALP400-20-SSB	Brushed Stainless Steel		220V
ALP400-20-WHI	White		220V



**BLACK**



**CHROME**



**GRAY**



**WHITE**

## WILLOW HIGH SPEED ELECTRIC HAND DRYER

- 8 second drying time
- Equipped with heat and speed controls
- Contains replaceable HEPA filter
- ADA compliant without recess kit
- 5-year limited warrant

**DIMENSIONS:** 12.6" x 11.25" x 3.93"

**CASE QUANTITY:** 4

**UNIT OF MEASURE:** Each



BRUSHED  
STAINLESS  
STEEL

ITEM#	FINISH		VOLTAGE
ALP405-10-BLK	Black		110V
ALP405-10-CHR	Chrome		110V
ALP405-10-GRY	Gray		110V
ALP405-10-WHI	White		110V
ALP405-10-SSB	Brushed Stainless Steel		110V





## STAINLESS STEEL WALL GUARD FOR ELECTRIC HAND DRYERS

**ITEM#** ALP400-WALLG

**DIMENSIONS:** 31.75" x 15.75" x 0.06"

**CASE QUANTITY:** 1

**UNIT OF MEASURE:** Each



**ADA COMPLIANT**

## RECESS KIT FOR HEMLOCK ELECTRIC HAND DRYER

**ITEM#** ALP400-RECESS

**DIMENSIONS:** 26" x 16.5" x 3.5"

**CASE QUANTITY:** 1

**UNIT OF MEASURE:** Each



**Vertical****BABY CHANGING STATION**

- Secure safety belt
- Antimicrobial coating
- Concave design for comfort
- Two convenient bag hooks
- Holds 100, easy-to-access, liners
- ASTM compliant

**ITEM #:** ALP411-V**DIMENSIONS:** 31.25" x 19" x 33"**CASE QUANTITY:** 1**UNIT OF MEASURE:** Each**CHILD SAFETY STRAP****TWO BAG HOOKS****DUAL LINER COMPARTMENTS**

**Horizontal**

**BABY CHANGING STATION**

- Secure safety belt
- Antimicrobial Coating
- Concave design for comfort
- Two convenient bag hooks
- Holds 50, easy-to-access, liners
- ASTM compliant

**ITEM #:** ALP411-E

**DIMENSIONS:** 19.8" x 32" x 18"

**CASE QUANTITY:** 1

**UNIT OF MEASURE:** Each

**WEIGHT CAPACITY:** 50 lbs.

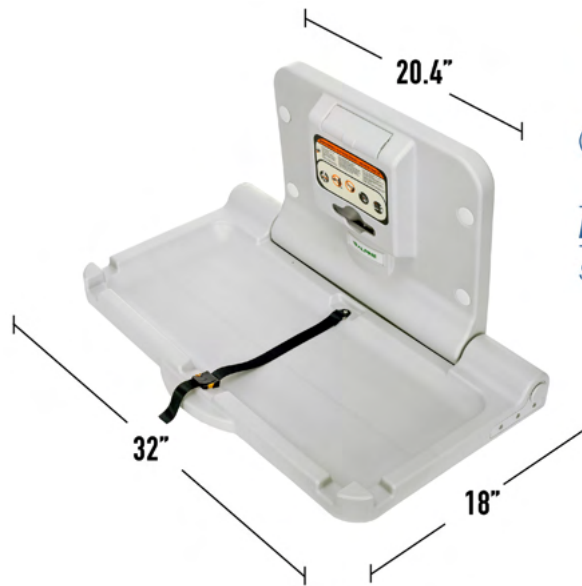

**CHILD SAFETY STRAP**



**EASY ACCESS LINER COMPARTMENT**



**TWO BAG HOOKS**





## STAINLESS STEEL SURFACE-MOUNTED WASTE RECEPTACLE

- Satin-finished surface is resilient to a variety of messes and is easy to sanitize
- Stainless steel clip is located inside the receptacle to hold trash bags in place
- 6.4 gallon waste capacity
- Outfitted with bag clips to hold the trash bag in place

**Item #:** ALP491

**Dimensions:** 18" H x 14" W x 6" D

**Unit Of Measure:** Each

**Finish:** Brushed Stainless Steel

**Case Quantity:** 1



## BRUSHED STAINLESS STEEL RECESSED PAPER TOWEL DISPENSER / WASTE RECEPTACLE

- Holds up to 600 C-fold or 800 multifold towels
- 12 Gallon waste capacity
- Keeps restrooms clean with space-saving efficiency
- Outfitted with bag clips to hold the trash bag in place

**ITEM#** ALP492

**DIMENSIONS:** 56" x 17" x 4"

**FINISH:** Brushed Stainless Steel

**CASE QUANTITY:** 1

**UNIT OF MEASURE:** Each



### BAG CLIPS TO KEEP YOUR RECEPTACLE TIDY



## RECESSED WASTE RECEPTACLE

- 12 Gallon waste capacity
- Keeps restrooms clean with space-saving efficiency
- Durable stainless steel with all-welded construction

**ITEM#** ALP493

**DIMENSIONS:** 29" x 17" x 4"

**FINISH:** Brushed Stainless Steel

**CASE QUANTITY:** 1

**UNIT OF MEASURE:** Each



**BRUSHED STAINLESS STEEL****SURFACE MOUNTED PAPER TOWEL DISPENSER / WASTE RECEPTACLE**

- Holds up to 350 C-fold or 475 multifold paper towels
- 2 Gallon waste capacity
- Keeps restrooms clean with space-saving efficiency
- Outfitted with bag clips to hold the trash bag in place

**ITEM#** ALP494**CASE QUANTITY:** 1**DIMENSIONS:** 28" x 14" x 4"**UNIT OF MEASURE:** Each**FINISH:** Brushed Stainless Steel

**HOLDS UP TO 350 C-FOLD OR  
475 MULTIFOLD PAPER TOWELS**



**2 GALLON  
WASTE RECEPTACLE  
CAPACITY**

**RECESSED PAPER TOWEL DISPENSER / WASTE RECEPTACLE**

- Holds up to 350 C-fold or 475 multifold paper towels
- Keeps restrooms clean with recessed space-saving efficiency
- 2 Gallon waste capacity
- Outfitted with bag clips to hold the trash bag in place

**ITEM#** ALP495**CASE QUANTITY:** 1**DIMENSIONS:** 28" x 14" x 4"**UNIT OF MEASURE:** Each**FINISH:** Brushed Stainless Steel**TRIFOLD/C-FOLD PAPER TOWEL DISPENSER,  
TRANSPARENT BLACK**

- Can hold approximately 300 sheets of Trifold or C-fold Paper Towels
- Equipped with a lock to prevent theft or tampering
- Allows for tear-free paper towel disposal, reducing waste
- Translucent cover allows you to see the paper supply and when it needs to be restocked

**Item #:** ALP480-ECO-TBLK**Dimensions:** 14.17" x 5.12" x 11.02"**Color:** Transparent Black**Case Quantity:** 3**Unit Of Measure:** Each**PAPER TOWEL ROLL DISPENSER,  
TRANSPARENT BLACK**

- Lever controls the amount the dispenser delivers
- Allows for tear-free paper towel disposal
- Translucent cover to see the paper supply
- Equipped with a lock to prevent theft or tampering

**Item #:** ALP454-ECO-TBLK**Dimensions:** 13.35" x 9.53" x 10.91"**Color:** Transparent Black**Case Quantity:** 2**Unit Of Measure:** Each

C-FOLD/MULTI-FOLD

PAPER TOWEL DISPENSER

- Holds up to 400 C-fold or 525 Multi-fold towels
- Stainless Steel 304
- Variety of colors/finishes

**CASE QUANTITY:** 8  
**UNIT OF MEASURE:** Each

ITEM#	DIMENSIONS
ALP480	14.5" x 11.2" x 4"
ALP480-AB	14.5" x 11.2" x 4"
ALP480-AC	14.5" x 11.2" x 4"
ALP480-AN	14.5" x 11.2" x 4"
ALP480-COP	14.5" x 11.2" x 4"

**ALP480**

BRUSHED STAINLESS STEEL



**ALP480-AB**

ANTIQUe BRONZE



**ALP480-AC**

ANTIQUe COPPER



**ALP480-AN**

ANTIQUe NICKEL



**ALP480-COP**

COPPER



FOR SMALLER SPACES

**ALP481**

BRUSHED STAINLESS STEEL



- Holds up to 290 C-fold or 380 multi-fold paper towels
- Stainless steel 304



- Holds up to 200 C-fold or 275 multi-fold paper towels
- Stainless steel 304

**TWO REPLACEMENT KEYS**  
FOR PAPER AND TISSUE DISPENSERS  
ITEM# ALP480-KEY  
CASE QUANTITY: 1  
UNIT OF MEASURE: Each

ITEM#	DIMENSIONS	CASE QUANTITY	UNIT OF MEASURE
ALP481	10.2" x 11.2" x 4"	10	Each
ALP481S	7" x 10.8" x 4"	14	Each



ACRYLIC WALL-MOUNTED PAPER TOWEL DISPENSER

- Accommodates 150 C-fold/multi-fold towels
- Equipped with bottom opening for easy towel dispensing

**DIMENSIONS:** 6.8" x 10.2" x 4"  
**CASE QUANTITY:** 12  
**UNIT OF MEASURE:** Each

ITEM#	FINISH
ALP432-CLR	Clear
ALP432-BLK	Black



### FREESTANDING PAPER TOWEL HOLDER

WITH TENSION ARM

- Accommodates any standard size paper towel roll

**ITEM#** ALP433-01  
**DIMENSIONS:** 12.8" x 6.69" x 6.69"  
**FINISH:** Stainless Steel  
**CASE QUANTITY:** 12  
**UNIT OF MEASURE:** Each



### FREESTANDING PAPER TOWEL HOLDER

WITH NON-SLIP BASE

- Accommodates any standard size paper towel roll

**ITEM#** ALP433-02  
**DIMENSIONS:** 12.8" x 5.9" x 5.9"  
**FINISH:** Stainless Steel  
**CASE QUANTITY:** 12  
**UNIT OF MEASURE:** Each

### FREESTANDING PAPER TOWEL HOLDER

- Accommodates any standard size paper towel roll

**DIMENSIONS:** 14" x 6.69" x 6.69"  
**CASE QUANTITY:** 12  
**UNIT OF MEASURE:** Each



ALP433-03



ALP433-04



ALP433-05



- Stainless Steel/Black
- Angled Top
- Rippled Base



- Bronze/Black
- Angled Top
- Rippled Base



- Stainless Steel/Black
- Round Top
- Smooth Base

### AVAILABLE IN AN ARRAY OF STYLES

### WASHROOM/RESTROOM ACCESSORIES / TISSUE BOX HOLDERS

**ALP405-BMB**  
Wooden Bamboo



**ALP405-ESP**  
Wooden Espresso



### SQUARE OR RECTANGLE TISSUE BOX HOLDER

- Durable acrylic, or natural woodgrain finish
- Slide-out bottom makes refilling easy
- Tear-free tissue retrieval



**ALP406-BMB**  
Wooden Bamboo



**ALP407-BLK**  
Black Acrylic

ITEM#	FINISH	SHAPE	DIMENSIONS	CASE QTY.
ALP405-BMB	Wooden Bamboo		Square 6.25" x 5.5" x 5.5"	12
ALP405-ESP	Wooden Espresso		Square 6.25" x 5.5" x 5.5"	12
ALP406-BMB	Wooden Bamboo		Rectangle 4.5" x 10.5" x 6"	12
ALP406-ESP	Wooden Espresso		Rectangle 4.5" x 10.5" x 6"	12
ALP407-BLK	Black Acrylic		Square 6.5" x 4.7" x 4.7"	16
ALP408-BLK	Black Acrylic		Rectangle 4" x 9.4" x 5.25"	16

## SINGLE ROLL TOILET PAPER HOLDER

### WITH SHELF STORAGE RACK



- Utility shelf for storing extra tissue or personal belongings
- Can hold a standard size roll

**DIMENSIONS:** 3.9" x 5.5" x 3.8"

**CASE QUANTITY:** 32

**UNIT OF MEASURE:** Each

ITEM#	FINISH	
ALP487-1-C	Chrome	
ALP487-1-B	Brushed Stainless Steel	

## DOUBLE ROLL TOILET PAPER HOLDER

### WITH SHELF STORAGE RACK





- Utility shelf for storing extra tissue or personal belongings
- Can hold two standard size rolls

**DIMENSIONS:** 3.9" x 10.5" x 3.9"

**CASE QUANTITY:** 18

**UNIT OF MEASURE:** Each

ITEM#	FINISH	
ALP487-C	Chrome	
ALP487-B	Brushed Stainless Steel	

## JUMBO BATH TISSUE DISPENSER



- Holds all brands of 9" diameter rolls
- Locking cover eliminates waste

**CASE QUANTITY:** 10

**UNIT OF MEASURE:** Each

ITEM#	FINISH	
ALP482	Brushed Stainless Steel	
ALP450-GRY	Plastic/Gray	





**SIDE-BY-SIDE**

**DOUBLE ROLL TOILET TISSUE DISPENSER**



- Accommodates two standard size bath tissue rolls
- Transfer paddle offers easy access to the second roll
- Locking cover eliminates waste

**ITEM#** ALP452-GRY

**DIMENSIONS:** 6.3" x 10.3" x 6.3"

**FINISH:** Gray Plastic

**CASE QUANTITY:** 12

**UNIT OF MEASURE:** Each



**TRANSPARENT BLACK**

**DOUBLE JUMBO ROLL TOILET PAPER DISPENSER**



- Sliding panel ensures that only one roll is used at a time
- Translucent cover allows you to see the paper supply
- Equipped with a lock to prevent theft or tampering
- Accommodates any 9" toilet paper roll brand, with a minimum core diameter of 2.5"

**Item #:** ALP482-ECO-TBLK

**Dimensions:** 11.85" x 4.80" x 20.28"

**Color:** Transparent Black

**Case Quantity:** 3

**Unit Of Measure:** Each

**Capacity:** 2 Toilet Paper Rolls





## 800ML MANUAL BULK SOAP/SANITIZER DISPENSER



- Dispenses up to 1000 times per fill
- Soap level indicating window
- Accommodates liquid soap/gel sanitizer

**DIMENSIONS:** 9.6" x 4.6" x 4.1"

**CAPACITY:** 800 mL

**CASE QUANTITY:** 12

**UNIT OF MEASURE:** Each

ITEM#	FINISH		SOAP/SANITIZER TYPE
ALP425-GRY	Gray		Liquid Soap/Gel Sanitizer
ALP425-WHI	White		Liquid Soap/Gel Sanitizer

### ALP423-SSB



**DIMENSIONS:**

8.1" x 4.8" x 2.8"

### ALP424-SSB



**DIMENSIONS:**

4.8" x 8.1" x 2.8"

## VERTICAL OR HORIZONTAL STAINLESS STEEL MANUAL SOAP DISPENSER

- Works with most free-flowing all purpose liquid hand soaps
- Accommodates liquid soap/gel sanitizer

**BUTTON STYLE:** Black/Plastic

**CAPACITY:** 1200mL

**CASE QUANTITY:** 20

**UNIT OF MEASURE:** Each

### ALP427-F-GRY

## MANUAL BULK SOAP/SANITIZER DISPENSER

- Soap level indicating window
- Indicated for: Foam Soaps/Sanitizers
- Accommodates foaming soap and sanitizer

**DIMENSIONS:** 8.75" x 4.2" x 3.25"

**CAPACITY:** 475mL

**CASE QUANTITY:** 30

**UNIT OF MEASURE:** Each



## REPLACEMENT KEY

FOR STAINLESS STEEL MANUAL  
SOAP DISPENSERS

**ITEM#** ALP423-424-K

**CASE QUANTITY:** 1

**UNIT OF MEASURE:** Each



## 1200ML AUTOMATIC HANDS-FREE BULK SOAP/SANITIZER DISPENSER WITH REMOVABLE DRIP TRAY

- Soap level indicating window
- Drip tray attached to keep floors clean

**DIMENSIONS:** 18.1" x 4.75" x 4.3"

**CASE QUANTITY:** 12

**CAPACITY:** 1200mL

**UNIT OF MEASURE:** Each

ITEM#	FINISH	SOAP/SANITIZER TYPE
ALP430-L-T	White	<input type="checkbox"/> Liquid Soap/Gel Sanitizer
ALP430-L-T-BLK	Black	<input checked="" type="checkbox"/> Liquid Soap/Gel Sanitizer
ALP430-F-T	White	<input type="checkbox"/> Foaming Soap/Sanitizer
ALP430-F-T-BLK	Black	<input checked="" type="checkbox"/> Foaming Soap/Sanitizer



## AUTOMATIC HANDS-FREE BULK SOAP/SANITIZER DISPENSER

**1200ML**

- Works with most free-flowing all purpose liquid/foam hand soaps

**DIMENSIONS:** 11.1" x 6" x 4.4"

**CASE QUANTITY:** 12

**CAPACITY:** 1200mL

**UNIT OF MEASURE:** Each

ITEM#	FINISH	SOAP/SANITIZER TYPE
ALP430-L-BLK	Black	<input checked="" type="checkbox"/> Liquid Soap/Gel Sanitizer
ALP430-F-BLK	Black	<input checked="" type="checkbox"/> Foaming Soap/Sanitizer
ALP430-L	White	<input type="checkbox"/> Liquid Soap/Gel Sanitizer
ALP430-F	White	<input type="checkbox"/> Foaming Soap/Sanitizer



## AC ADAPTER FOR 430-SERIES DISPENSER

**ITEM#** ALP430-ADAPTER

**CASE QUANTITY:** 1





**UNIT OF MEASURE:** Each



**1200ML****AUTOMATIC HANDS-FREE BULK  
SOAP/SANITIZER DISPENSER****WITH FLOOR STAND**

- Sleek floor stand allows to you to place dispensers anywhere they are needed

**DIMENSIONS:** 55.5" x 14.5" x 14.5"**CAPACITY:** 1200 mL**CASE QUANTITY:** 1**UNIT OF MEASURE:** Each

ITEM#	FINISH		SOAP/SANITIZER TYPE
ALP430-L-S	White		Liquid Soap/Gel Sanitizer
ALP430-L-S-BLK	Black		Liquid Soap/Gel Sanitizer
ALP430-F-S	White		Foaming Soap/Sanitizer
ALP430-F-S-BLK	Black		Foaming Soap/Sanitizer

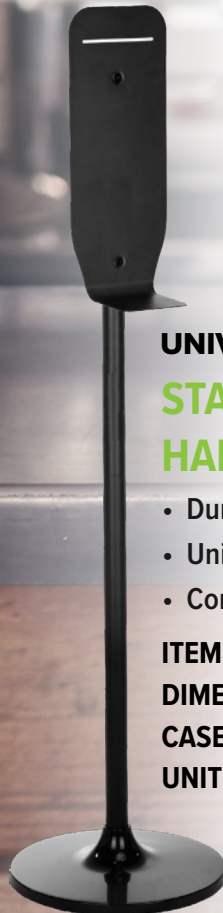
**UNIVERSAL****STAND WITH DRIP TRAY FOR  
HAND SANITIZER/SOAP DISPENSERS**

- Durable powder-coated black metal construction
- Universally designed for most soap/sanitizer dispensers
- Conveniently place anywhere

**ITEM#** ALP430-STAND-BLK**DIMENSIONS:** 55.5" x 14.9" x 14.9"**CASE QUANTITY:** 1**UNIT OF MEASURE:** Each

**BLACK**



**WHITE**



**PURPLE**



**BRUSHED STAINLESS STEEL**



**WALL-MOUNTABLE**

**SANITARY NAPKIN RECEPTACLE**

- Plastic receptacles include removable leakproof plastic inner liner

**UNIT OF MEASURE:** Each

ITEM#	FINISH		DIMENSIONS	CASE QTY.
ALP451-BLK	Plastic, Black		10" x 9" x 5"	6
ALP451-WHI	Plastic, White		10" x 9" x 5"	6
ALP451-PUR	Plastic, Purple		10" x 9" x 5"	6
ALP451-SSB	Stainless Steel		10" x 7.5" x 5"	14

**STEP-ON**

**SANITARY NAPKIN RECEPTACLE**



- Slim design looks great and saves space
- Hands-free lid with foot-operated trigger

**DIMENSIONS:** 23" x 7.1" x 13"

**UNIT OF MEASURE:** Each

**CASE QUANTITY:** 1

ITEM#	FINISH	
ALP451-19-WHI	Plastic, White	
ALP451-19-GRY	Plastic, Gray	

WASHROOM/RESTROOM ACCESSORIES / GRAB BARS



**STAINLESS STEEL SAFETY GRAB BARS**

- 1 1/4" in diameter
- Brushed 304 stainless steel
- Flange-covered mounting hardware for a clean, professional appearance

**FINISH:** Brushed Stainless Steel

**UNIT OF MEASURE:** Each

ITEM#	CASE QUANTITY	DIMENSIONS
ALP484-12	24	12" Straight
ALP484-18	24	18" Straight
ALP484-24	20	24" Straight
ALP484-30	14	30" Straight
ALP484-36	12	36" Straight
ALP484-42	10	42" Straight
ALP484-48	10	48" Straight



## PLASTIC TOILET SEAT COVER DISPENSER

- Covers are dispensed one at a time
- Slim design looks great and saves space

**ITEM#** ALP453

**FINISH:** Black/Plastic

**DIMENSIONS:** 11.42" x 16.14" x 2.36"

**CASE QUANTITY:** 20

**UNIT OF MEASURE:** Each



## TOILET SEAT COVERS

### 250 SHEETS/SLEEVE

- Flushable and biodegradable
- 250 sheets/sleeve

**DIMENSIONS:** 10.63" x 15.27" x 2.75"

**UNIT OF MEASURE:** Case

**CASE QUANTITY:** 1

ITEM#	PACK QUANTITY
ALPP400	3 Pack
ALPP400-C	20 Pack





## STAINLESS STEEL TOILET SEAT COVER DISPENSER

- Dispense covers one at a time

**ITEM#** ALP483

**FINISH:** Brushed Stainless Steel

**DIMENSIONS:** 11.8" x 15.7" x 2"

**CASE QUANTITY:** 1

**UNIT OF MEASURE:** Case





# JANITORIAL AND CLEANING SUPPLIES

## SUBCATEGORIES

Umbrella Accessories .....	31
Mop Buckets .....	32
Mops and Mopping Accessories .....	33
Brooms .....	37
Sweepers .....	38
Dustpans .....	38
Hooks and Holders .....	39
Floor Squeegees .....	40
Glove Dispensers .....	41
Scrapers .....	41



## UMBRELLA STAND

### WITH 100 BAGS

- Reduces housekeeping maintenance and labor from rainy day mop-ups
- Built-in sign frame for customizing your own messages
- Umbrella bag comes with handles for an easy carry

**ITEM#:** ALP489  
**DIMENSIONS:** 48" x 12" x 12"  
**CASE QUANTITY:** 1  
**UNIT OF MEASURE:** Each



## UMBRELLA BAGS

- Equipped with an easy carry handle on each bag

**UNIT OF MEASURE:** Pack

ITEM#	PACK QTY.	DIMENSIONS	CASE QTY.
ALP489-100	100	29" x 5.5"	50
ALP489-TOU	1,000	29" x 5.5"	4









**36 QUART****MOP BUCKET WITH SIDE WRINGER/DOWN PRESS WRINGER**

- Non-marking casters with bumper guard
- Rounded front lip to prevent back-splash while emptying contents

**DIMENSIONS:** 35" x 15" x 25"**CAPACITY:** 36 Quart**CASE QUANTITY:** 1**UNIT OF MEASURE:** EachNON-MARKING  
CASTER WHEELS

SIDE WRINGER

DOWN PRESS  
WRINGER

ITEM#	FINISH		DIMENSIONS
ALP462	Yellow		Alpine 36 Qt Mop Bucket with Side Wringer
ALP462-BLU	Blue		Alpine 36 Qt Mop Bucket with Side Wringer
ALP462-BRN	Brown		Alpine 36 Qt Mop Bucket with Side Wringer
ALP462-GRN	Green		Alpine 36 Qt Mop Bucket with Side Wringer
ALP462-GRY	Gray		Alpine 36 Qt Mop Bucket with Side Wringer
ALP462-RED	Red		Alpine 36 Qt Mop Bucket with Side Wringer
ALP462-1	Yellow		Alpine 36 Qt. Mop Bucket with Down Press Wringer



## ALL-IN-ONE DUST MOP

**INCLUDES: MOP HEAD, FRAME, AND TELESCOPIC HANDLE**

- Rust-resistant, black powder-coated metal wire frame
- Features a unique snap-lock for 180-degree swivel action or rigid position
- 60" Aluminum telescoping handle

**CASE QUANTITY: 1**

**UNIT OF MEASURE:** Each

ITEM#	SIZE	MATERIAL	DIMENSIONS
ALP434-24	24 Inch	Cotton	60" x 24" x 5.5"
ALP434-48	48 Inch	Cotton	60" x 48" x 5.5"
ALP435-24	24 Inch	Microfiber	60" x 24" x 5.5"
ALP434-36	36 Inch	Cotton	60" x 36" x 5.5"
ALP435-48	48 Inch	Microfiber	60" x 48" x 5.5"



**60 INCH MAX TELESCOPIC HANDLE**



**REMOVABLE MOPHEAD**



**SOFT COTTON**



**GENTLE MICROFIBER**





## WHITE, LOOP-END MOP HEADS

With Color-Coded 1" and 5" Headbands & Tailbands, 12 Pack

**DIMENSIONS:** ALP301-SERIES

**COLOR:** White

**UNIT OF MEASURE:** 12 Pack

**MATERIAL:** Cotton Blend



- Ideal for commercial and industrial applications as well as larger spaces
- Reduces your cleaning time with its ample spread and won't tangle in the process

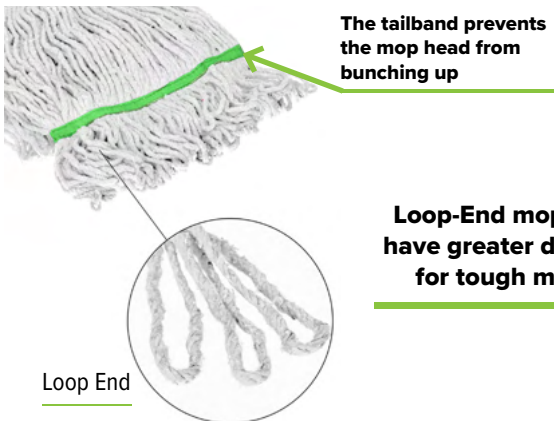

**Loop-End mop heads have greater durability for tough messes**

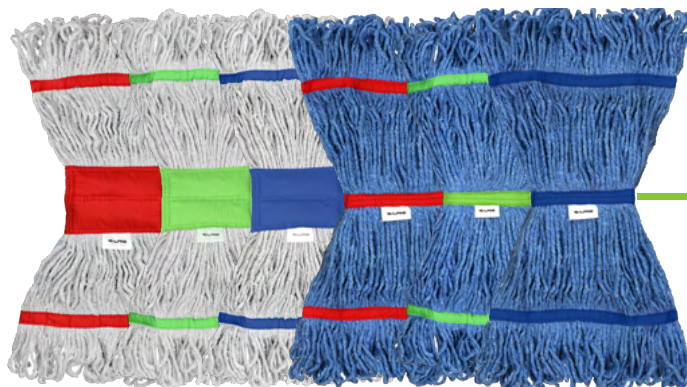

## WHITE, CUT-END MOP HEADS

With 1" and 5" Headbands, 12 Pack

**DIMENSIONS:** ALP300-SERIES

**COLOR:** White

**UNIT OF MEASURE:** 12 Pack

**MATERIAL:** Cotton Blend



- Ideal for soaking up spills or one-time use
- The perfect mop head for smaller, more compact areas
- Can either be hand washed or disposed of after use

**Cut-end mop heads increase absorbency and are budget-friendly**

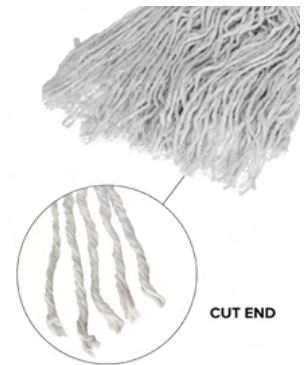

## BLUE, LOOP-END MOP HEADS

With Color-Coded 1" and 5" Headbands & Tailbands, 12 Pack

**DIMENSIONS:** ALP301-SERIES

**COLOR:** White

**UNIT OF MEASURE:** 12 Pack

**MATERIAL:** Cotton Blend



- Can either be hand washed or disposed of after use
- Ideal for commercial and industrial applications as well as larger spaces
- Reduces your cleaning time with its ample spread and won't tangle in the process

**Color-coded mop heads help prevent cross-contamination in your facility**

**RECOMMENDED FLOOR TYPES:**

- Laminate
- Hardwood
- Rubber-Based
- Smooth-Concrete
- Terrazzo
- Pavers
- Quarry Stone
- Vinyl
- Smooth Ceramic
- Anti-Slip Tile



MOP HEADS	MOP ENDS	COLOR	HEADBAND SIZE	MAX CAPACITY	IDEAL HANDLES
ALP300-01-1W-12PK	Cut-End	White	1-Inch	16 oz.	Quick Change
ALP300-01-5W-12PK	Cut-End	White	5-Inch	16 oz.	Jaw
ALP300-02-1W-12PK	Cut-End	White	1-Inch	24 oz.	Quick Change
ALP300-02-5W-12PK	Cut-End	White	5-Inch	24 oz.	Jaw
ALP300-03-1W-12PK	Cut-End	White	1-Inch	32 oz.	Quick Change
ALP300-03-5W-12PK	Loop-End	White	5-Inch	32 oz.	Jaw
ALP301-01-1R-12PK	Loop-End	Red	1-Inch	16 oz.	Quick Change
ALP301-01-5R-12PK	Loop-End	Red	5-Inch	16 oz.	Jaw
ALP301-02-1G-12PK	Loop-End	Green	1-Inch	24 oz.	Quick Change
ALP301-02-5G-12PK	Loop-End	Green	5-Inch	24 oz.	Jaw
ALP301-03-1B-12PK	Loop-End	Blue	1-Inch	32 oz.	Quick Change
ALP301-03-5B-12PK	Loop-End	Blue	5-Inch	32 oz.	Jaw
ALP302-01-1R-12PK	Loop-End	Red	1-Inch	16 oz.	Quick Change
ALP302-01-5R-12PK	Loop-End	Red	5-Inch	16 oz.	Jaw
ALP302-02-1G-12PK	Loop-End	Green	1-Inch	24 oz.	Quick Change
ALP302-02-5G-12PK	Loop-End	Green	5-Inch	24 oz.	Jaw
ALP302-03-1B-12PK	Loop-End	Blue	1-Inch	32 oz.	Quick Change
ALP302-03-5B-12PK	Loop-End	Blue	5-Inch	32 oz.	Jaw

## REPLACEMENT DUST MOP HEAD

- Easily cleans away all kinds of dust and debris

**QUANTITY:** Pack of 2

**UNIT OF MEASURE:** Each

ITEM#	SIZE	MATERIAL	DIMENSIONS	CASE QTY.
ALP434-24-2	24 Inch	Cotton	1" x 24" x 5.5"	20
ALP434-36-2	36 Inch	Cotton	1" x 36" x 5.5"	15
ALP434-48-2	48 Inch	Cotton	1" x 48" x 5.5"	10
ALP435-24-2	24 Inch	Microfiber	1" x 24" x 5.5"	20
ALP435-36-2	36 Inch	Microfiber	1" x 36" x 5.5"	15
ALP435-48-2	48 Inch	Microfiber	1" x 48" x 5.5"	10

### COTTON



### MICROFIBER



## DUST MOP HEAD FRAME

- Designed to enable quick and effortless attachment of mop head
- Made of rust-resistant, powder-coated metal wire for a long life
- Accepts the industry-standard clip-on dust mop handles

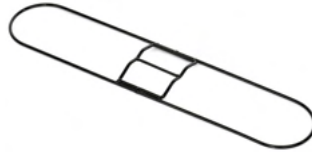

**CASE QUANTITY:** 24

**UNIT OF MEASURE:** Each

ITEM#	SIZE	DIMENSIONS
ALP436-24	24 Inch	0.9" X 24" X 5"
ALP436-36	36 Inch	0.9" X 35" X 5"
ALP436-48	48 Inch	0.9" X 47" X 5"

QUICK CHANGE FIBERGLASS

JAW FIBERGLASS



## DUST MOP HANDLES

- Handle can be easily stored on a storage hook

**DIMENSIONS:** 60" (35"- 60" for Telescopic)

**UNIT OF MEASURE:** Each

ITEM#	TYPE	CASE QTY.
ALP444-4	Fiberglass	12
ALP444-5	Telescopic	14

FIBERGLASS



TELESCOPIC



## WET MOP HANDLES

- Handle can be easily stored on a storage hook

**DIMENSIONS:** 55 Inches

**CASE QUANTITY:** 12

**UNIT OF MEASURE:** Each

ITEM#	TYPE	MATERIAL
ALP444-1	Quick Change	Fiberglass
ALP444-3	Jaw	Fiberglass
ALP444-2-3	Quick-Change (3 Pack)	Fiberglass

## PUSH BROOMS

- Long-lasting bristles for years to come
- Dual threaded holes to allow switching sides of the bristle block for even bristle wear
- Mid-grip foam wrap provides comfort and control for increased performance
- Includes push broom head and 55" handle

**DIMENSIONS:** 55-inch handle

**CASE QUANTITY:** 6

**UNIT OF MEASURE:** Each



**REVERSIBLE BROOM HEAD FOR EVEN BRISTLE WEAR**



**ENFORCED METAL TIP OUTLASTS THE PLASTIC FIXTURE ON OTHER BRANDS**

ITEM#	SIZE	SURFACE TYPE	ITEM#	SIZE	SURFACE TYPE
ALP460-18-1	18 Inch	Multi-Surface	ALP460-24-1	24 Inch	Multi-Surface
ALP460-18-2	18 Inch	Smooth Surface	ALP460-24-2	24 Inch	Smooth Surface
ALP460-18-3	18 Inch	Rough Surface	ALP460-24-3	24 Inch	Rough Surface



**MULTI-SURFACE**





**SMOOTH SURFACE**



**ROUGH SURFACE**





ITEM#	FINISH	
ALP469-RED-NEW	Red	
ALP469-BLACK-NEW	Black	

**TRIPLE BRUSH****SUPERIOR PICK UP CARPET SWEEPER**

- Convenient to use with no cords, bags, or batteries, just push and go
- Works on most floor surfaces, including tile, vinyl, hardwood, and carpeted floors
- Comb included for keeping brush rollers free from hair and debris
- 11-inch wide sweeping path to get the job done

**DIMENSIONS:** 42.5" x 7.87"**CASE QUANTITY:** 4**UNIT OF MEASURE:** Each**BRISTLE CLEANING BRUSH INCLUDED!**

## JANITORIAL AND CLEANING SUPPLIES / DUSTPANS

**HEAVY-DUTY****METAL DUST PAN**

- Unbreakable and rust-resistant
- Thin edge for optimum dirt pick up
- Suitable for indoor and outdoor use

**UNIT OF MEASURE:** Each

ITEM#	SIZE	CASE QTY.
ALP4999-12	12 inch	24
ALP4999-17	17 inch	12





**STANDARD**

**MOP/BROOM HOLDER**

- 5 flexible mounting slots to grip and hold handles in place
- 6 retractable hooks for hanging tools, dusters, etc.
- Easy to use - push handles into self-adjustable mounting slots for tidy storage and retrieval

**ITEM#:** ALP498-GRY

**CAPACITY:** 5 CLIPS / 6 HOOKS

**DIMENSIONS:** 2.48" x 15.62" x 3.26"

**CASE QUANTITY:** 40

**UNIT OF MEASURE:** Each



1 CLIP / 2 HOOKS



4 CLIPS / 5 HOOKS

**QUICK ADJUST**

**MOP/BROOM HOLDERS**

- 4 flexible mounting slots to grip and hold handles in place
- 5 retractable hooks for hanging tools, dusters, etc.
- Easy to use - push handles into self-adjustable mounting slots for tidy storage and retrieval

**DESCRIPTION:** 5 CLIPS / 6 HOOKS

ITEM#	CAPACITY	DIMENSIONS	UNIT OF MEASURE	CASE QTY.
ALP498-4	4 Clips / 5 Hooks	1.7" x 20" x 2.4"	Each	36
ALP498-1	1 Clip / 2 Hooks	1.2" x 4.6" x 2"	Each	192
ALP498-1-D	2 Pack: 1 Clip/ 2 Hooks	1.2" x 4.6" x 2"	Pack	96

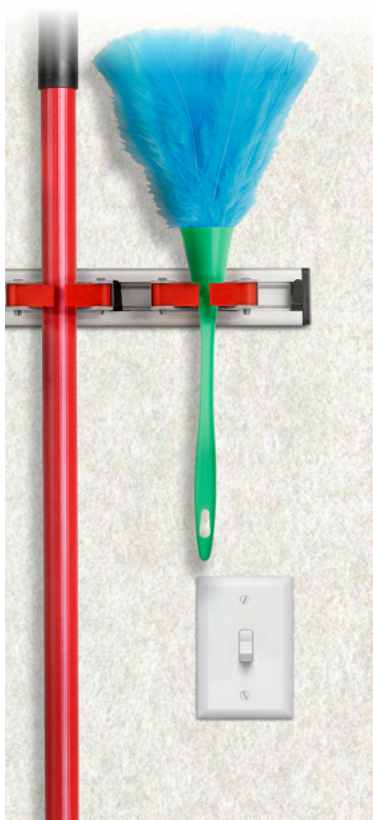

**CLIPS AND HOOKS TO MAXIMIZE YOUR STORAGE CAPACITY**

**STANDARD****FLOOR SQUEEGEES**

- Efficiently cleans dirt and debris from uneven floor surfaces
- For use with standard tapered handles (Sold separately)
- Screw-locking clamp easily accommodates standard tapered handles

**SQUEEGEE MATERIAL:** Foam**UNIT OF MEASURE:** Each

ITEM#	SIZE	FINISH	DIMENSIONS	CASE QTY.
ALP440-18	18 in	Metal	6" x 18" x 2"	48
ALP440-22	22 in	Metal	6" x 22" x 2"	24

**HEAVY-DUTY****FLOOR SQUEEGEES**

- Efficiently cleans dirt and debris from uneven floor surfaces
- For use with standard tapered handles (Sold separately)
- Screw-locking clamp easily accommodates standard tapered handles

**SQUEEGEE MATERIAL:** Foam**CASE QUANTITY:** 24**UNIT OF MEASURE:** Each**CURVED****FLOOR SQUEEGEES**

- Curved rubber blade removes a large volume of water and debris
- For use with standard tapered handles (Sold separately)
- Screw-locking clamp easily accommodates standard tapered handles

ITEM#	SIZE	DIMENSIONS
ALP443-24	24 in	7" x 24" x 1"
ALP443-36	36 in	7" x 36" x 1"

**FLOOR SQUEEGEES****WITH HANDLE**

- Includes a 55" tapered handle that securely holds the blade in place
- Handles uneven surfaces
- Steel handle

**SQUEEGEE MATERIAL:** Foam**CASE QUANTITY:** 1**UNIT OF MEASURE:** Each

ITEM#	DIMENSIONS
ALP441-18-ST	18-inch / 55-inch handle
ALP441-30-ST	30-inch / 55-inch handle



**GLOVE BOXES  
NOT INCLUDED!**

HOLDS  
**1**  
BOX



HOLDS  
**2**  
BOXES



HOLDS  
**3**  
BOXES



HOLDS  
**4**  
BOXES



**WIRE GLOVE DISPENSERS**

- Universal design fits most glove brands
- Constructed of metal
- Tough and sturdy
- Can be mounted vertically or horizontally

**UNIT OF MEASURE:** Each

ITEM#	COLOR	BOX QTY.	DIMENSIONS	CASE QTY.
ALP485-01-BLA	Black	1	4" x 10" x 3.8"	24
ALP485-01-WHI	White	1	4" x 10" x 3.8"	24
ALP485-02-BLA	Black	2	10.5" x 10.75" x 3.8"	12
ALP485-02-WHI	White	2	10.5" x 10.75" x 3.8"	12
ALP485-04-BLA	Black	3	15" x 10.75" x 3.8"	12
ALP485-04-WHI	White	3	15" x 10.75" x 3.8"	12
ALP485-05-BLA	Black	4	20" x 10.75" x 3.8"	12
ALP485-05-WHI	White	4	20" x 10.75" x 3.8"	12

**ACRYLIC**

**GLOVE DISPENSER**

- Made using clear, acrylic material to supply long-term durability and use
- Universal design that fits most glove brands

**ITEM#:** ALP488-01

**BOX CAPACITY:** 1

**DIMENSIONS:** 5.3" x 10.2" x 3.5"

**CASE QUANTITY:** 1

**UNIT OF MEASURE:** Each

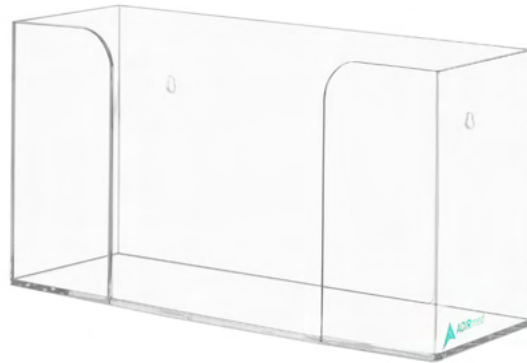

JANITORIAL AND CLEANING SUPPLIES / SCRAPERS



**4-INCH  
WINDOW  
SCRAPER**

- Comes with 10 replacement blades
- PVC grip for comfort and control

**ITEM#:** ALP437

**DIMENSIONS:** 12" x 4.1" x 1.1"

**CASE QUANTITY:** 60

**UNIT OF MEASURE:** Each



**REPLACEMENT  
BLADES**

**ITEM#:** ALP437-RB

**BLADE COUNT:** 10

**DIMENSIONS:** 4.3" x 0.8"  
(Each Blade)

**CASE QUANTITY:** 300

**UNIT OF MEASURE:** Pack



# ODOR CONTROL SUPPLIES

## SUBCATEGORIES

Urinal Screens .....	43
Air Fresheners .....	44

## DELUXE URINAL SCREEN

### 10 PACK

- 10x more fragrant than vinyl screens. Deodorizes up to 30 days
- Efficiently eliminates 99% of splashback and averts clogging
- Flexible 8-sided design snugly fits any urinal configuration
- 10 individually wrapped screens per case
- Dual-sided, position it in any way

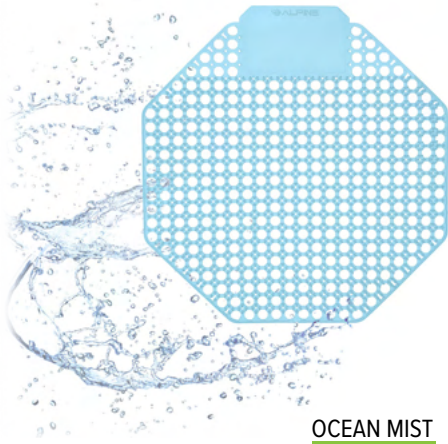

OCEAN MIST

ITEM#	SCENT
ALP4111-SA	Spiced Apple
ALP4111-OM	Ocean Mist
ALP4111-MANGO	Mango
ALP4111-KG	Kiwi Grapefruit

ITEM#	SCENT
ALP4111-CM	Cucumber Melon
ALP4111-CHERRY	Cherry
ALP4111-CB	Cotton Blossom

### AVAILABLE IN A VARIETY OF SCENTS



SPICED APPLE



MANGO



KIWI GRAPFRUIT



CHERRY



CUCUMBER MELLON



COTTON BLOSSOM



SPIKES TO KEEP IT IN PLACE



WATER EASILY PASSES THROUGH WHEN FLUSHING

## URINAL SCREEN

### WITH BLOCK - 12 PACK

- Non-para block
- Water soluble and will not clog drains

ITEM#: ALP4333-1

DIMENSIONS: 6.5" x 6.5"

CASE QUANTITY: 10

UNIT OF MEASURE: Pack



## ODOR CONTROL SUPPLIES / AIR FRESHENERS



ALP429-1  
CLASSIC



ALP429-2  
DELUXE

### METERED AEROSOL

## AIR FRESHENER DISPENSERS

- Accommodates most standard metered aerosols
- Adjustable spray interval settings: 8, 15, and 25 minutes

**[DELUXE FEATURE] SET IT UP YOUR WAY:** Integrated light sensor LED for automatic settings / Programmable LCD for manual settings





# BUSINESS / RESTAURANT SIGNAGE

## SUBCATEGORIES

Facility Signs.....	46
LED Signs .....	50
Tabletop Signs .....	52

## CAUTION FLOOR SIGN

- Durable plastic lays flat for easy storage
- Built-in handle for ease of transportation and storage
- Large bold text is easily readable
- Indoor and outdoor use

**DIMENSIONS:** 24.6" x 11.8"



ITEM#	TYPE	UNITY OF MEASURE
ALP499	Wet Floor Sign, Yellow	Each





## WOODEN WET FLOOR SIGN

- Folds with ease, for a simple storage solution
- Clear and large text in both English and Spanish

**DIMENSIONS:** 24" x 15"

**CASE QUANTITY:** 1

**UNIT OF MEASURE:** Each

ITEM#	FACE PLATE FINISH
ALP499-SSB	Stainless Steel 
ALP499-BRA	Brass 

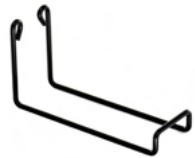

**HOLDS UP TO 7 FLOOR SIGNS**



## CAUTION FLOOR SIGN HOLDER

- Securely holds up to 7 floor signs
- High-grade steel construction for enhanced durability

**ITEM#:** ALP499-HOLDER

**DIMENSIONS:** 5.3" x 3.5" x 10"

**CASE QUANTITY:** 24

**UNIT OF MEASURE:** Each



## POP-UP WET FLOOR SIGN

- Folds with ease, for a simple storage solution
- Clear and large text in both English and Spanish
- Sign holder included for easy storage

**DIMENSIONS:** 24" x 15"

**CASE QUANTITY:** 12

**UNIT OF MEASURE:** Each

ITEM#	SIZE
ALP498-20	20 in
ALP498-30	30 in



**DIMENSIONS:** 13" x 53"  
**CASE QUANTITY:** 24  
**UNIT OF MEASURE:** Each

## HANGING SAFETY SIGN

- Adjustable pole expands from 30 inches to 53 inches
- Clear and large text in both English and Spanish

**ITEM #:** ALP498-HAN



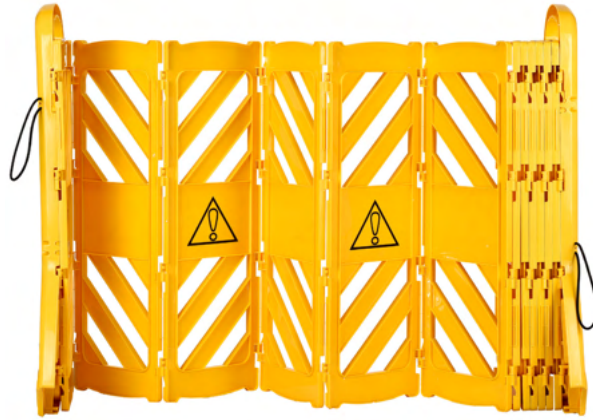

**OPENS UP  
TO 13 FEET**

**MOBILE  
SAFETY BARRIER**

- Measures 13' x 40" fully extended
- Flexible panels can be used in curved or straight configurations
- Tilts and rolls easily on two 5" wheels
- Four locking straps to secure in closed position

**ITEM#:** ALP499-BAR

**DIMENSIONS:**

40" x 156" x 1" (Fully opened)

40" x 23" x 13" (Fully closed)

**CASE QUANTITY:** 1

**UNIT OF MEASURE:** Each



**CONVENIENT  
CARRY HANDLE**



**WHEELS FOR  
EASY MOBILITY**



**BUNGEE CORDS FOR  
HELPFUL STORAGE**



**DURABLE JOINTS  
FOR LONGEVITY**





ALPSGN-1



ALPSGN-3



ALPSGN-5



ALPSGN-2



ALPSGN-4



ALPSGN-6



ALPSGN-39

**9-INCH X 6-INCH**

## PLASTIC RESTROOM AND ACCESS SIGNS

- All signs have braille characters to meet ADA regulations
- Double-sided mounting tape included

**DIMENSIONS:** 9" x 6" x 0.2"

**CASE QUANTITY:** 48

**UNIT OF MEASURE:** Each

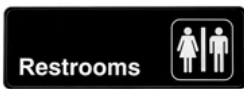

ALPSGN-20



ALPSGN-10

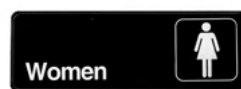

ALPSGN-19



ALPSGN-29

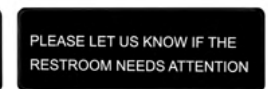

ALPSGN-31

**3-INCH X 9-INCH**

## PLASTIC RESTROOM AND ACCESS SIGNS

- Double-sided mounting tape included for easy installation

**DIMENSIONS:** 3" x 9" x 0.2"

**CASE QUANTITY:** 48

**UNIT OF MEASURE:** Each

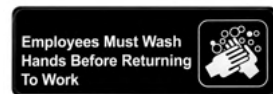

ALPSGN-38



ALPSGN-30

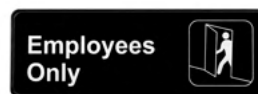

ALPSGN-21



ALPSGN-41

**ALL 3 SIGNS INCLUDED TOGETHER**

**3-INCH X 9-INCH**

## EMPLOYEE SIGNS

- Double-sided mounting tape included for easy installation

**DIMENSIONS:** 3" x 9" x 0.2"

**CASE QUANTITY:** 48

**UNIT OF MEASURE:** Each

**3-INCH X 9-INCH**

## ENTRANCE AND EXIT SIGNS

- Double-sided mounting tape included for easy installation



ALPSGN-35

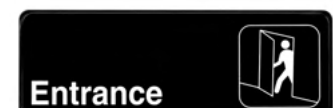

ALPSGN-15

**DIMENSIONS:** 3" x 9" x 0.2"

**CASE QUANTITY:** 48

**UNIT OF MEASURE:** Each



ALPSGN-26

**3-INCH X 9-INCH**

**NO SMOKING AND SMOKING SIGNS**

- Double-sided mounting tape included for easy installation

**DIMENSIONS:** 3" x 9" x 0.2"  
**CASE QUANTITY:** 48  
**UNIT OF MEASURE:** Each



ALPSGN-9



ALPSGN-37



ALPSGN-33

**3-INCH X 9-INCH**

**PROHIBITIVE AND PERMISSIVE SIGNS**

- Double-sided mounting tape included for easy installation

**DIMENSIONS:** 3" x 9" x 0.2"  
**CASE QUANTITY:** 48  
**UNIT OF MEASURE:** Each

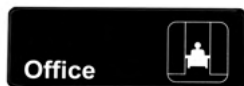

ALPSGN-7



ALPSGN-36



ALPSGN-32

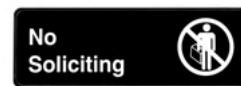

ALPSGN-28

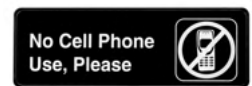

ALPSGN-27

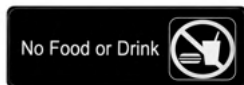

ALPSGN-22



ALPSGN-14

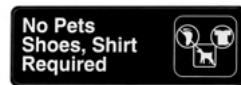

ALPSGN-13



ALPSGN-11

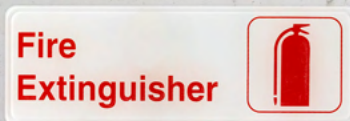

**3-INCH X 9-INCH**

**FIRE EXTINGUISHER SIGN**

- Double-sided mounting tape included for easy installation

**ITEM#:** ALPSGN-34  
**DIMENSIONS:** 3" x 9" x 0.2"  
**CASE QUANTITY:** 48  
**UNIT OF MEASURE:** Each



**A-STAND LED ILLUMINATED**

**WOODEN MESSAGE WRITING BOARD**

- Includes 8 colored markers, remote control, cleaning towel, power adapter, and user manual

**CASE QUANTITY:** 1  
**UNIT OF MEASURE:** Each

ITEM#	FINISH	DIMENSIONS	SHELF
ALP491-03	White	45.2" x 15.75" x 0.6"	No



ALP491-03

**► INCLUDES:**

- 8 COLORED MARKERS
- REMOTE CONTROL
- CLEANING TOWEL
- POWER ADAPTER



**LED ILLUMINATED**

**HANGING MESSAGE WRITING BOARD**

- Includes 8 colored markers, remote control, erasing towel, power adapter, hanging chain, and user manual
- Can be used vertically or horizontally with hanging chain

**CASE QUANTITY:** 5  
**UNIT OF MEASURE:** Each



ITEM#	DIMENSIONS
ALP495-02	15.75" x 23.6" x 0.5"
ALP495-03	19.7" x 27.6" x 0.5"
ALP495-04	23.6" x 31.5" x 0.5"
ALP495-05	31.5" x 39.4" x 0.5"

**► INCLUDES:**

- 8 COLORED MARKERS
- REMOTE CONTROL
- CLEANING TOWEL
- POWER ADAPTER



**8 COLORED**

**MARKERS FOR LED MESSAGE BOARDS**

**ITEM#:** ALP497-8  
**DIMENSIONS:**  
5.39" x 4.72" x 0.59"

**CASE QUANTITY:** 1  
**UNIT OF MEASURE:** Pack

**CUSTOMIZE YOUR OWN MESSAGE!**

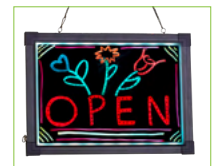

## LED OPEN SIGNS



ALP497-02  
LARGE OVAL

- 2 display modes: flashing or steady
- Equipped with hanging chain and plug-in adapter



ALP497-04  
VERTICAL

- Equipped with hanging chain and plug-in cord
- On/off button makes operation convenient and easy

**CASE QUANTITY:** 10

**UNIT OF MEASURE:** Each

ITEM#	DIMENSIONS
ALP497-02	14" x 23" x 1"
ALP497-04	19" x 10" x 1"

### PROGRAMMABLE

## LED OPEN SIGN



- Programmable message area holds up to 99 messages up to 80 characters long
- Equipped with flashing mode switch, remote control, 12-Volt power adapter and hanging chain

ITEM#: ALP497-10  
 DIMENSIONS: 13" x 22.04" x 1.57"  
 CASE QUANTITY: 5  
 UNIT OF MEASURE: Each



**REMOTE INCLUDED TO CUSTOMIZE YOUR MESSAGE**



**AC ADAPTER AND USER GUIDE INCLUDED**

## LED FOOD SIGNS

- 2 display modes: flashing or steady
- Equipped with hanging chain and plug-in adapter

ITEM#	DIMENSIONS	CASE QTY.
ALP497-05	14" x 23" x 1"	10
ALP497-07	14" x 23" x 1"	10
ALP497-08	10" x 19" x 1"	10
ALP497-11	10" x 19" x 1"	5
ALP497-13	10" x 19" x 1"	5
ALP497-14	10" x 19" x 1"	5



ALP497-05  
LARGE

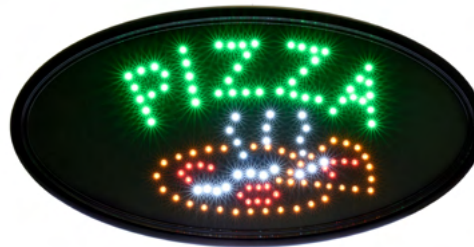

ALP497-07  
LARGE



ALP497-08  
SMALL



ALP497-11

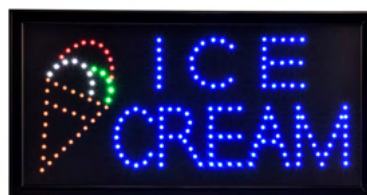

ALP497-13



ALP497-14

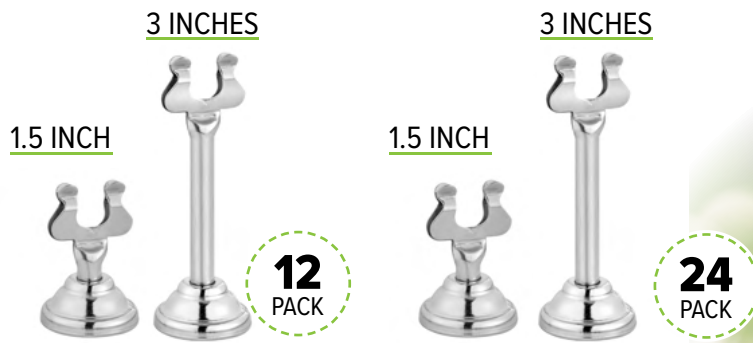

## PLACE CARD AND TABLE NUMBER HOLDERS

- Polished stainless steel construction holds cards securely

UNIT OF MEASURE: Pack

**CARDS NOT INCLUDED**

ITEM#	DIMENSIONS	PACK QTY.	CASE QTY.
ALP494-12-CRM	1.5" x 1" x 1"	12 Pack	30
ALP494-24-CRM	1.5" x 1" x 1"	24 Pack	60
ALP495-12-CRM	3" x 1" x 1"	12 Pack	30
ALP495-24-CRM	3" x 1" x 1"	24 Pack	60



DOUBLE-SIDED

### PLASTIC TABLE NUMBERS (1-50)

- Features bold black numbering on both sides of each card
- Made of ultra-smooth PVC sheet plastic for longevity and ease of cleaning

ITEM#: ALP4933-1-50

DIMENSIONS: 3.75" x 4"

CASE QUANTITY: 50

UNIT OF MEASURE: Each



DOUBLE-SIDED

### PLASTIC TABLE NUMBERS (51-100)

- Features bold black numbering on both sides of each card
- Made of ultra-smooth PVC sheet plastic for longevity and ease of cleaning

ITEM#: ALP4933-51-100

DIMENSIONS: 3.75" x 4"

CASE QUANTITY: 50

UNIT OF MEASURE: Each

**SELF-STANDING**

**NUMBER CARDS**



- Features bold black numbering that is easily visible from a distance
- Stackable for simple storage
- Made from heavy-duty, sturdy plastic

**DIMENSIONS:** 3" x 3"

**CASE QUANTITY:** 1

**UNIT OF MEASURE:** Each

ITEM#	NUMBERS
ALP493-1-25	1-25
ALP493-26-50	26-50

ITEM#	NUMBERS
ALP493-51-75	51-75
ALP493-76-100	76-100





# **WATER** **FOUNTAIN**

## **SUBCATEGORIES**

Indoor/Outdoor Water Fountain .....	55
-------------------------------------	----





## WALL MOUNTED INDOOR/OUTDOOR WATER FOUNTAIN

**Item #:** ALP700-01

**Diameter:** 11.02" \* 1.96"

**Dimensions:** 8.8" x 12.7" x 14"

**Total Weight Capacity:** Up to 100 lbs.

**Unit Of Measure:** Each

**Case Quantity:** 1

**A long-lasting fountain that will provide fresh drinking water.**



### CONSTRUCTION:

Able to be utilized indoors or outdoors.



### DESIGN:

The rounded edges prevent injury to the user.



### INCLUDED:

For convenience, we've included all necessary plumbing attachments.



### ONE-FINGER OPERATION:

You can have fresh water at the press of a button.





# RESTAURANT FURNITURE AND SUPPLIES





## SUBCATEGORIES

Baby High Chairs .....	57
Child Booster Seats .....	58
Napkin Dispensers .....	59

**WOOD**

**BABY HIGH CHAIRS**

- ASTM Certified
- Top Quality: Made from sturdy rubberwood
- Wide A-frame for tip resistance and safety belts preinstalled
- Ships disassembled

ITEM#	QTY	COLOR	
ALP412-01-ESP	Each	Espresso	
ALP412-01-MA	Each	Mahogany	
ALP412-02-ESP	2 Pack	Espresso	
ALP412-02-MA	2 Pack	Mahogany	



**DIMENSIONS:** 29" x 17.72" x 19.5"  
**CASE QUANTITY:** 1





**DIMENSIONS:** 29" x 17.72" x 19.5"  
**CASE QUANTITY:** 2



**WOOD****CHILD BOOSTER SEATS**

- Top Quality: Made from sturdy rubberwood
- Safety belts are preinstalled and made from a thick nylon weave
- Ships disassembled



ITEM#	QTY	COLOR	
ALP413-01-ESP	Each	Espresso	
ALP413-01-MA	Each	Mahogany	
ALP413-02-ESP	2 Pack	Espresso	
ALP413-02-MA	2 Pack	Mahogany	

**DIMENSIONS:** 11.6" x 11.8" x 12"  
**CASE QUANTITY:** 1

**DIMENSIONS:** 11.6" x 11.8" x 12"  
**CASE QUANTITY:** 2



**INTER-FOLD**

**TABLETOP NAPKIN DISPENSERS**

- 250 napkin capacity
- Advertising insert allows you to display menu offerings, upcoming events, or messages
- Caddy can hold other items like condiments

**CASE QUANTITY:** 10

**UNIT OF MEASURE:** Each

ITEM#	CADDY	DIMENSIONS
ALP4332	No	6.5" x 8" x 5.9"
ALP4332-C	Yes	6.5" x 14.17" x 6"



WITH CADDY



**DISPENSER CADDY**

**ONLY**

**ITEM#:** ALP4333-CADDY

**DIMENSIONS:** 2.67" x 14.17" x 6"

**CASE QUANTITY:** 10

**UNIT OF MEASURE:** Each



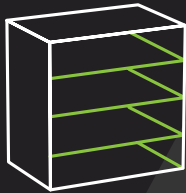

# STORAGE AND SHELVING

## SUBCATEGORIES

Lockers .....	60
Key Cabinets .....	65
Magazine Racks .....	69

**24-INCH****SINGLE TIER LOCKERS**

- 2 internal hooks for coats, hats, backpacks, and sports gear
- Dual locking option: 2 keys (included) or works with combination lock or padlock (not included)
- Rubber feet to prevent floor damage

**DIMENSIONS:** 24" x 15" x 15"**WEIGHT:** 18 lbs**CONSTRUCTION:** Solid Steel**CASE QUANTITY:** 1**UNIT OF MEASURE:** Each**AVAILABLE IN A VARIETY OF COLORS**

ADI629-02-BLU  
BLUE



ADI629-02-GRN  
GREEN



ADI629-02-PUR  
PURPLE



ADI629-02-RED  
RED



NAME TAG SLOT FOR PERSONALIZATION



INNER HOOKS FOR MORE STORAGE



VENTED DOOR FOR AIRFLOW



**48-INCH****SINGLE TIER LOCKERS**

- 2 internal hooks and shelves for coats, hats, backpacks, and sports gear
- Dual locking option: 2 keys (included) or works with combination lock or padlock (not included)
- Rubber feet to prevent floor damage
- Name tag slot for personalization
- Adjustable shelving

**DIMENSIONS:** 48" x 15" x 15"**WEIGHT:** 36 lbs**CONSTRUCTION:** Solid Steel**CASE QUANTITY:** 1**UNIT OF MEASURE:** Each

ADI629-01-BLU  
BLUE

ADI629-01-GRN  
GREEN

ADI629-01-PUR  
PURPLE

ADI629-01-RED  
RED

**72-INCH****SINGLE TIER LOCKERS**

- 2 internal hooks and shelves for coats, hats, backpacks, and sports gear
- Dual locking option: 2 keys (included) or works with combination lock or padlock (not included)
- Rubber feet to prevent floor damage
- Name tag slot for personalization
- Adjustable shelving

**DIMENSIONS:** 72" x 12" x 12"**WEIGHT:** 41 lbs**CONSTRUCTION:** Solid Steel**CASE QUANTITY:** 1**UNIT OF MEASURE:** Each

ADI629-201-BLK  
BLACK

ADI629-201-BLU  
BLUE

ADI629-201-GRN  
GREEN

ADI629-201-PUR  
PURPLE

ADI629-201-RED  
RED





ADI629-202-BLK  
BLACK



ADI629-202-BLU  
BLUE



ADI629-203-GRN  
GREEN



ADI629-202-PUR  
PURPLE



ADI629-202-RED  
RED

**72-INCH**

**DOUBLE TIER LOCKERS**

**DIMENSIONS:** 72" x 12" x 12"

**WEIGHT:** 41 lbs

**CONSTRUCTION:** Solid Steel

**CASE QUANTITY:** 1

**UNIT OF MEASURE:** Each

- 2 internal hooks and shelves for coats, hats, backpacks, and sports gear
- Dual locking option: 2 keys (included) or works with combination lock or padlock (not included)
- Rubber feet to prevent floor damage
- Vented door for airflow
- Name tag slot for personalization
- Adjustable shelving



ADI629-203-BLK  
BLACK



ADI629-203-BLU  
BLUE



ADI629-203-GRN  
GREEN



ADI629-203-PUR  
PURPLE



ADI629-203-RED  
RED

**72-INCH**

**THREE TIER LOCKERS**

**DIMENSIONS:** 72" x 12" x 12"

**WEIGHT:** 41 lbs

**CONSTRUCTION:** Solid Steel

**CASE QUANTITY:** 1

**UNIT OF MEASURE:** Each

- Each door has 2-keys
- Dual locking option, 2 keys (included) or your own combination lock or padlock (not included)
- Name tag slot for personalization
- 2 internal hooks for coats, hats, backpacks, and sports gear
- Vented door for airflow
- 3 separate compartments



ADI629-204-BLK  
BLACK



ADI629-204-BLU  
BLUE



ADI629-204-GRN  
GREEN



ADI629-204-PUR  
PURPLE



ADI629-204-RED  
RED

## 72-INCH

## FOUR TIER LOCKERS

**DIMENSIONS:** 72" x 12" x 12"

**WEIGHT:** 41 lbs

**CONSTRUCTION:** Solid Steel

**CASE QUANTITY:** 1

**UNIT OF MEASURE:** Each

- Each door has 2-keys
- Dual locking option, 2 keys (included) or your own combination lock or padlock (not included)
- Name tag slot for personalization
- 2 internal hooks for coats, hats, backpacks, and sports gear
- Vented door for airflow
- 4 separate compartments

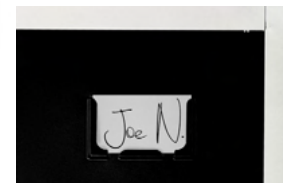
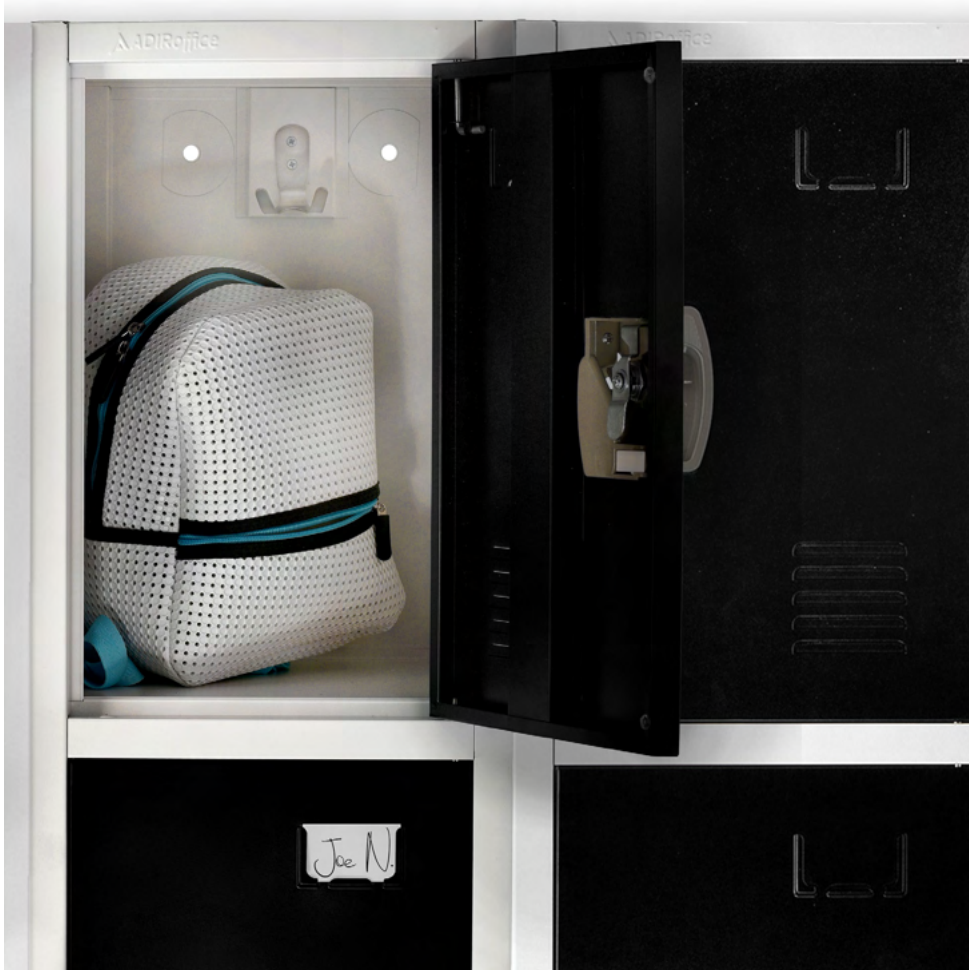

**NAME TAG SLOT FOR PERSONALIZATION**



**INNER HOOKS FOR MORE STORAGE**



**DUAL LOCKING OPTIONS**



ADI629-206-BLK  
BLACK



ADI629-206-BLU  
BLUE



ADI629-206-GRN  
GREEN



ADI629-206-PUR  
PURPLE



ADI629-206-RED  
RED

## 72-INCH

### SIX TIER LOCKERS

**DIMENSIONS:** 72" x 12" x 12"

**WEIGHT:** 41 lbs

**CONSTRUCTION:** Solid Steel

**CASE QUANTITY:** 1

**UNIT OF MEASURE:** Each

- Each door has 2-keys
- Dual locking option, 2 keys (included) or your own combo or padlock (not included)
- Name tag slot for personalization
- 2 internal hooks for coats, hats, backpacks, sports gear
- Vented door for airflow
- 6 separate compartments



**ADI681-30-SERIES**



HOLDS  
**30**  
SETS OF  
KEYS



**KEY LOCKING**

**KEY STORAGE CABINETS**

- Key hooks and tags included
- Security lock with 2 entry keys
- Includes screw and wall anchors for easy mounting and setup

**CONSTRUCTION:** Steel  
**UNIT OF MEASURE:** Each

**ADI681-48-SERIES**



HOLDS  
**48**  
SETS OF  
KEYS

ITEM#	CAPACITY	COLOR		DIMENSIONS	CASE QTY.
ADI681-30-BLK	30 Sets of keys	Black	■	8" x 6.4" x 3.1"	10
ADI681-30-RED	30 Sets of keys	Red	■	8" x 6.4" x 3.1"	10
ADI681-30-WHI	30 Sets of keys	White	□	8" x 6.4" x 3.1"	10
ADI681-48-BLK	48 Sets of keys	Black	■	10" x 7.1" x 3.1"	10
ADI681-48-BLU	48 Sets of keys	Blue	■	10" x 7.1" x 3.1"	10
ADI681-48-RED	48 Sets of keys	Red	■	10" x 7.1" x 3.1"	10
ADI681-48-WHI	48 Sets of keys	White	□	10" x 7.1" x 3.1"	10



**ADI682-30-SERIES**



HOLDS  
**30**  
SETS OF  
KEYS



**COMBINATION LOCK**

**KEY STORAGE CABINETS**

- Key hooks and tags included
- Combination lock with over 1,000 re-settable combinations
- Includes screw and wall anchors for easy mounting and setup

**CONSTRUCTION:** Steel

**UNIT OF MEASURE:** Each

**ADI682-48-SERIES**



HOLDS  
**48**  
SETS OF  
KEYS

ITEM#	CAPACITY	COLOR	DIMENSIONS	CASE QTY.
ADI682-30-BLK	30 Sets of keys	Black	8" x 6.4" x 3"	10
ADI682-30-RED	30 Sets of keys	Red	8" x 6.4" x 3"	10
ADI682-30-WHI	30 Sets of keys	White	8" x 6.4" x 3"	10
ADI682-48-BLK	48 Sets of keys	Black	10" x 7.1" x 3"	10
ADI682-48-BLU	48 Sets of keys	Blue	10" x 7.1" x 3"	10
ADI682-48-RED	48 Sets of keys	Red	10" x 7.1" x 3"	10
ADI682-48-WHI	48 Sets of keys	White	10" x 7.1" x 3"	10

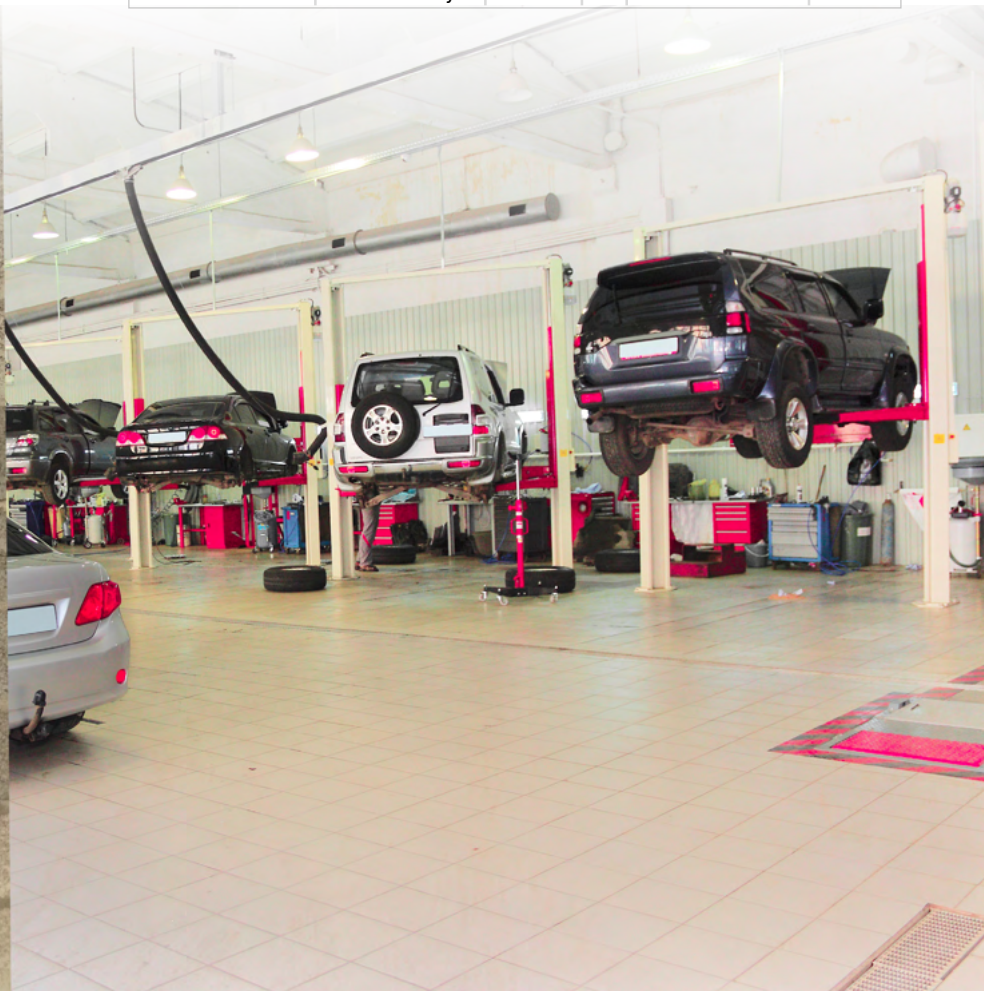

**HEAVY-DUTY****KEY CABINETS****WITH COMBINATION LOCK**

- Key hooks and tags included
- Combination lock with over 1,000 re-settable combinations
- Includes screw and wall anchors for easy mounting and setup

**DIMENSIONS:** 12" x 7.8" x 2.3"**KEY CAPACITY:** 40 Sets of Keys**CONSTRUCTION:** Heavy-duty steel**CASE QUANTITY:** 10**UNIT OF MEASURE:** EachADI682-40-BLKCOMBINATION LOCKCOMPACT DESIGN**KEY CABINETS****WITH DIGITAL LOCK**

- Key hooks and tags included
- Keypad digital programmable lock
- 3 to 8 digit passcode length

**DIMENSIONS:** 14.3" x 13" x 4"**KEY CAPACITY:** 40 Sets of keys**CONSTRUCTION:** Steel**CASE QUANTITY:** 10**UNIT OF MEASURE:** Each

HOLDS  
**40**  
SETS OF  
KEYS

ADI680-40-BLKADI680-40-BLUADI680-40-REDADI680-40-WHI

**HEAVY-DUTY  
KEY CABINETS**

**WITH DUAL DIGITAL/KEYED LOCK**

- Key hooks and tags included
- Combination lock with over 1,000 re-settable combinations
- Dual key, combination lock
- Color-coded, numbered key hook bars



**ITEM#:** ADI683-100-BLK

**DIMENSIONS:** 21.7" x 15" x 3.25"

**KEY CAPACITY:** 100 Sets of Keys

**CONSTRUCTION:** Heavy-duty steel

**CASE QUANTITY:** 10

**UNIT OF MEASURE:** Each

**BOTH INCLUDE:**



COLOR-CODED HOOKS



COLOR-CODED TAGS



**30  
PACK**

**50  
PACK**

**100  
PACK**

**WHITE  
KEY TAGS**

- Durable, write-on plastic for easy identification
- Rugged metal snap hook holds keys securely
- Slim profile ideal for key storage cabinets
- Perfectly sized to fit all keys

ITEM#	CASE QUANTITY	UNIT OF MEASURE
ADI689-30	20	Pack of 20
ADI689-50	66	Pack of 30
ADI689-100	40	Pack of 50



**20  
PACK**

**MULTI-COLORED  
KEY TAGS**

- Durable, write-on plastic for easy identification
- Rugged metal snap hook holds keys securely
- Slim profile ideal for key storage cabinets
- Perfectly sized to fit all keys

**ITEM#:** ADI689-20-COLORED  
**CASE QUANTITY:** 100  
**UNIT OF MEASURE:** Pack

ADI640-2023-BLK



ADI640-2923-BLK



ADI640-3020-CLR



ADI640-2935-BLK



ADI640-5110-BLK



ADI640-5120-BLK



## ACRYLIC WALL-MOUNTABLE MAGAZINE RACKS

- Accommodates 8.5 x 11 magazines and slim 4 x 9 brochures
- Adjustable pockets are customizable to hold both magazines and brochures
- Clear acrylic for easy viewing

**CONSTRUCTION:** Acrylic

**CASE QUANTITY:** 1

**UNIT OF MEASURE:** Each

ITEM#	SLOTS	COLOR	DIMENSIONS
ADI640-2023-BLK	8	Black/Clear	23" x 20" x 2"
ADI640-2023-CLR	8	Clear	23" x 20" x 2"
ADI640-2923-BLK	12	Black/Clear	23" x 29" x 2"
ADI640-2923-CLR	12	Clear	23" x 29" x 2"
ADI640-3020-BLK	12	Black/Clear	20" x 30" x 2"
ADI640-3020-CLR	12	Clear	20" x 30" x 2"
ADI640-2935-BLK	18	Black/Clear	35" x 29" x 2"
ADI640-2935-CLR	18	Clear	35" x 29" x 2"
ADI640-5110-BLK	20	Black/Clear	51" x 10" x 4"
ADI640-5110-CLR	20	Clear	51" x 10" x 4"
ADI640-2948-BLK	24	Black/Clear	48" x 29" x 2"
ADI640-2948-CLR	24	Clear	48" x 29" x 2"
ADI640-5120-BLK	48	Black/Clear	51" x 20" x 4"
ADI640-5120-CLR	48	Clear	51" x 20" x 4"

ADI640-2948-BLK





## WOODEN

## FLOOR STAND MAGAZINE RACKS

- 6-tiers
- Accommodates 8.5" x 11" magazines and slim 4" x 9" brochures
- Detachable hooks for displaying different sized magazines or brochures
- Features 18.5" L" x 6" H acrylic front panel hook bars

DIMENSIONS: 47" x 20" x 12"

CASE QUANTITY: 1

UNIT OF MEASURE: EACH



ADI640-4020-BLK  
BLACK



ADI640-4020-MA  
MAHOGANY

► **PERFECT FOR  
WAITING ROOMS  
AND BREAK ROOMS**



ACRYLIC FRONT PANEL



SPACERS FOR BROCHURES





# FURNITURE

## SUBCATEGORIES

Lecterns .....	73
Furniture Carts .....	77



ADI661-02  
CLEAR



ADI661-02-BLK  
TRANSPARENT  
BLACK



ADI661-03-CLR  
CLEAR



ADI661-03-BLK  
TRANSPARENT  
BLACK

**DIMENSIONS:**

**ADI661-02-SERIES:** 47" x 26" x 13"

**ADI661-03-SERIES:** 47" x 26.75" x 12.5"

**ACRYLIC**

**STAND-UP LECTERNS**

- Heavy-duty 1/2" acrylic construction
- Angled top with paper stop

**CONSTRUCTION:** Acrylic

**CASE QUANTITY:** 1

**UNIT OF MEASURE:** Each



**LIPPED EDGE**

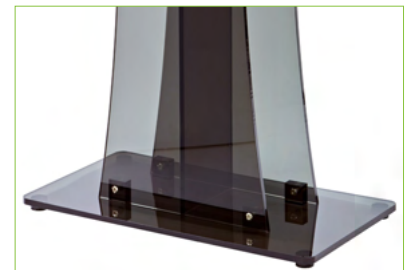

**STURDY BASE**



**GREAT FOR  
PRESENTATIONS  
OF ALL KINDS**



ADI661-01  
MAHOGANY



ADI661-01-BLK  
BLACK



ADI661-01-SIL  
SILVER



ADI661-01-WHI  
WHITE

## WOOD

### STAND-UP LECTERNS

- Pencil slot on table surface
- Stain and scratch-resistant surface
- Wide storage shelf inside
- Angled top with paper stop

**DIMENSIONS:** 45.8" x 23" x 15"

**CASE QUANTITY:** 1

**UNIT OF MEASURE:** Each

## WOOD

### STAND-UP LECTERNS

#### WITH DRAWER

- Features a tray area with 6-inch high backing and sides to hide presentation materials from the audience
- Drawer space: 21" x 10"
- 29.75" height storage space
- Stain and scratch-resistant surface

**DIMENSIONS:** 43.3" x 27.55" x 14"

**CASE QUANTITY:** 1

**UNIT OF MEASURE:** Each



ADI661-012-BLK  
BLACK



ADI661-012-CH  
CHERRY WOODGRAIN



ADI661-05-BLK  
BLACK



ADI661-05-MEO  
MEDIUM OAK



ADI661-05-WHI  
WHITE

**FOLDABLE WOOD**

**TABLETOP LECTERNS**

- Easy to fold
- Stain and scratch-resistant surface
- Angled top with paper stop
- Convenient and easy transportation
- Compact design for optimal storage

**CONSTRUCTION:** WOOD

**DIMENSIONS:** 19.25" x 27" x 16"

**CASE QUANTITY:** 1

**UNIT OF MEASURE:** Each



**REMOVABLE TOP AND FOLDABLE DESIGN FOR EASY STORAGE**

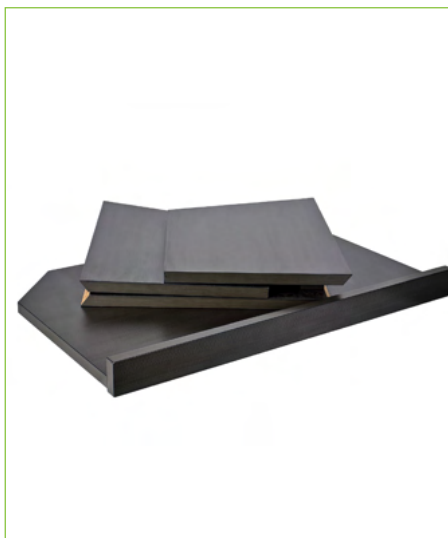

**MOBILE WOOD****HOSTESS /  
PRESENTATION STAND****WITH WHEELS**

- Two shelves at the back of the podium for storing essential items
- 4 wheels for easy transportation
- Stain and scratch-resistant surface

**CONSTRUCTION:** Wood**DIMENSIONS:** 46" x 24" x 17"**CASE QUANTITY:** 1**UNIT OF MEASURE:** Each

ADI661-07-BLK  
BLACK



ADI661-07-MEO  
MEDIUM OAK



ADI661-07-WHI  
WHITE

**WHEELS FOR  
EASY MOBILITY****CONVENIENT  
STORAGE SHELF**

## UNIVERSAL STANDING LECTERN COVER



- Shields your lectern from scratches, chips, and dust
- Moderate-abrasion-resistant material keeps your finish in peak condition
- Matching polyester pouch for protection when the cover is not being used

Item #: ADI661-COVER-BLK

Dimensions: 49" x 24.2" x 17.7"

Color: Black

Case Quantity: 50

Unit Of Measure: Each

**HOLDS UP TO 84 CHAIRS!**



## FOLDING CHAIR CART

- Slightly angled arms to keep chairs in place during transport
- Cart fits through standard size doorways

ITEM#: ADI690-03

DIMENSIONS: 76.18" x 64.8" x 33"

WEIGHT CAPACITY: 600 lbs.

CONSTRUCTION:

Heavy-gauge steel

CASE QUANTITY: 1

UNIT OF MEASURE: Each

## FURNITURE / FURNITURE CARTS



## COMBO

## CHAIR AND TABLE CART

- Includes bungee cords to strap tables on for transportation
- Cart fits through standard size doorways
- Heavy-duty design with crossbars made with 14-gauge steel and vertical bars made with 7-gauge channel steel
- Quick and easy assembly

ITEM#: ADI690-01

DIMENSIONS: 67" x 65" x 33.7"

WEIGHT CAPACITY: 600 lbs.

CONSTRUCTION: Heavy-gauge steel

CASE QUANTITY: 1

UNIT OF MEASURE: Each

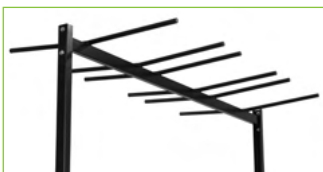

**HEAVY-DUTY CHAIR HANGERS**



**WHEELS WITH LOCKS FOR EASY MOBILITY**



**INCLUDED BUNGIES TO SECURE TABLES**



# OFFICE FURNITURE

## SUBCATEGORIES

Storage and Organization .....	79
Bulletin Boards .....	90



**11-COMPARTMENTS**



ADI500-11-BLK

**12-COMPARTMENTS**



ADI500-12-BLK

**16-COMPARTMENTS**



ADI500-16-BLK

**ALL SORTER SHELVES ARE ADJUSTABLE**



**24-COMPARTMENTS**



ADI500-24-BLK

**36-COMPARTMENTS**



ADI500-36-BLK

**PAPER SORTERS**

- Adjustable shelving
- 11.8-inch shelf depth accommodates standard-sized papers
- Rugged wood construction

**CASE QUANTITY:** 1  
**UNIT OF MEASURE:** Each

**ALL PAPER SORTERS AVAILABLE IN THESE ADDITIONAL COLORS:**



WHITE



MEDIUM OAK

ITEM#	COMPARTMENTS	COLOR	DIMENSIONS
ADI500-11-BLK	11	Black	16.2" x 10.75" x 11.75"
ADI500-11-MEO	11	Medium Oak	16.2" x 10.75" x 11.75"
ADI500-11-WHI	11	White	16.2" x 10.75" x 11.75"
ADI500-12-BLK	12	Black	16.3" x 20" x 11.8"
ADI500-12-MEO	12	Medium Oak	16.3" x 20" x 11.8"
ADI500-12-WHI	12	White	16.3" x 20" x 11.8"
ADI500-16-BLK	16	Black	21.4" x 20" x 11.8"
ADI500-16-MEO	16	Medium Oak	21.4" x 20" x 11.8"
ADI500-16-WHI	16	White	21.4" x 20" x 11.8"
ADI500-24-BLK	24	Black	16.3" x 39.3" x 11.8"
ADI500-24-MEO	24	Medium Oak	16.3" x 39.3" x 11.8"
ADI500-24-WHI	24	White	16.3" x 39.3" x 11.8"
ADI500-36-BLK	36	Black	23.9" x 39.3" x 11.8"
ADI500-36-MEO	36	Medium Oak	23.9" x 39.3" x 11.8"
ADI500-36-WHI	36	White	23.9" x 39.3" x 11.8"

## 20-SLOT, EXTRA WIDE PAPER SORTER

- Stackable design
- Equipped with removable top dowels to prevent sliding when stacked
- Adjustable shelf height
- Beautifully finished fiberboard wood

**DIMENSIONS:** 15" x 38.25" x 12"

**NUMBER OF SLOTS:** 20

**CASE QUANTITY:** 1

**UNIT OF MEASURE:** Each



ADI503-20-BLK  
BLACK



ADI503-20-MEO  
MEDIUM OAK



ADI503-20-WHI  
WHITE

## WOOD STACKABLE DESKTOP ORGANIZER

- Stackable
- Removable shelves
- Medium-density fiberboard construction

**DIMENSIONS:** 11" x 14" x 9.8"

**CASE QUANTITY:** 1

**UNIT OF MEASURE:** Each



ADI502-01-BLK  
BLACK



ADI502-01-MEO  
MEDIUM OAK



ADI502-01-WHI  
WHITE



## WOODEN 27 COMPARTMENT LITERATURE ORGANIZER

**Dimensions:** 21.65" x 31.49" x 11.81"

**Each Compartment:** 5.12" x 3.27"

**Color:** White

**Unit Of Measure:** Each

**Number of Slots:** 27

**Quantity:** 1



ADIOF201-01-WHI  
WHITE

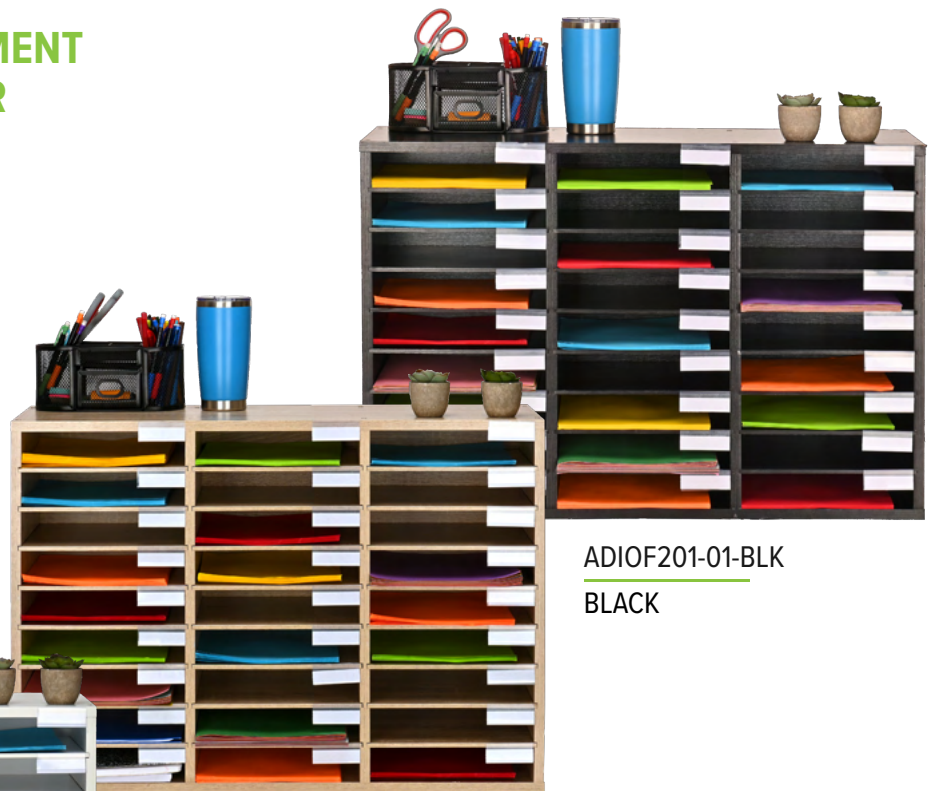

ADIOF201-01-BLK  
BLACK

ADIOF201-01-MEO  
MEDIUM OAK



- Contemporary organizer seamlessly blends in with your environment
- Compartments can be adjusted in 2" increments
- Each shelf is made from MDF, guaranteeing its strength for holding heavy loads
- Etched grooves comfortably support your shelves



**15-SLOT****CARDBOARD PAPER SORTER**

- Slots measure 1.7" x 10" x 12.5"
- Each slot features a small tab for precise labeling
- Eco-friendly durable cardboard construction
- Accommodates standard-sized papers





**DIMENSIONS:** 17" x 32" x 13"**NUMBER OF SLOTS:** 15**CASE QUANTITY:** 1**UNIT OF MEASURE:** Each

ITEM#	COLOR	
ADI501-15-BLK	Black	
ADI501-15-BLU	Blue	
ADI501-15-WHI	White	

**30-SLOT****CARDBOARD PAPER SORTER**

- Slots measure 1.7" x 10" x 12.5"
- Each slot features a small tab for precise labeling
- Eco-friendly durable cardboard construction
- Accommodates standard-sized papers

**DIMENSIONS:** 21" x 32" x 13"**NUMBER OF SLOTS:** 30**CASE QUANTITY:** 1**UNIT OF MEASURE:** Each

ITEM#	COLOR	
ADI501-30-BLK	Black	
ADI501-30-BLU	Blue	
ADI501-30-PUR	Purple	
ADI501-30-WHI	White	

**ALSO AVAILABLE IN THESE ADDITIONAL COLORS:****BLUE****PURPLE****WHITE**

**6-SLOT**

**CARDBOARD PAPER SORTER**

- Slots measure 2.5" x 11" x 12.5"
- Eco-friendly, durable cardboard construction
- Accommodates standard-sized papers

**DIMENSIONS:** 17.7" x 12" x 13.6"

**NUMBER OF SLOTS:** 6

**CASE QUANTITY:** 1

**UNIT OF MEASURE:** Each



ADI501-06-BLK  
BLACK



ADI501-06-PUR  
PURPLE

**CONTENTS SHOWN NOT INCLUDED**



ADI501-15-CP-BLU

BLUE

**LARGE**

**CONSTRUCTION PAPER SORTER**

- 15-same-size file slots measuring 1.75" x 9.25"
- Each slot features a small tab for precise labeling
- Eco-friendly, durable cardboard construction

**DIMENSIONS:** 9.5" x 29" x 13"

**NUMBER OF SLOTS:** 15

**CASE QUANTITY:** 1

**UNIT OF MEASURE:** Each



HOLDS  
**20**  
ROLLS



HOLDS  
**21**  
ROLLS

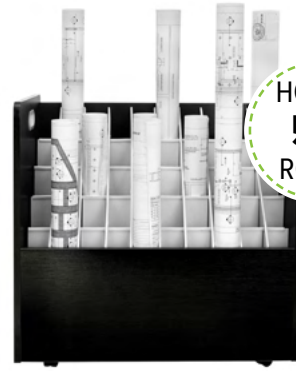

HOLDS  
**50**  
ROLLS

**AVAILABLE IN THESE ADDITIONAL COLORS:**



WHITE



MAHOGANY

**PAPER ROLLS NOT INCLUDED.**

**MOBILE**

**ROLL STORAGE**

- Fits rolled sheets or documents up to 2.75" in diameter
- 50 lb. weight capacity
- Made from durable wood composite to provide long-lasting strength and use
- Four swiveling casters on the bottom facilitate easy movement of your files to suit your convenience
- Side handles make it easy to access and transport the unit to multiple locations

**CASE QUANTITY:** 1

**UNIT OF MEASURE:** Each

ITEM#	COMPARTMENTS	COLOR	DIMENSIONS
ADI624-BLK	20	Black	24.75" x 15.25" x 13.25"
ADI624-MA	20	Mahogany	24.75" x 15.25" x 13.25"
ADI624-WHI	20	White	24.75" x 15.25" x 13.25"
ADI625-BLK	21	Black	28.5" x 30" x 15.75"
ADI625-MA	21	Mahogany	28.5" x 30" x 15.75"
ADI625-WHI	21	White	28.5" x 30" x 15.75"
ADI626-BLK	50	Black	28.5" x 30" x 15.75"
ADI626-MA	50	Mahogany	28.5" x 30" x 15.75"
ADI626-WHI	50	White	28.5" x 30" x 15.75"

**25" MAX ROLL HEIGHT****37" MAX ROLL HEIGHT****ROLL STORAGE****WITH COVER**

- Eco-friendly, durable cardboard construction
- Fits rolled sheets or documents up to 2.75" in diameter
- Labeling grid on the front and top allow you to write down which file is stored in each slot
- Side handles make it easy to access and transport the unit to multiple locations

**COLOR:** White**CASE QUANTITY:** 1**UNIT OF MEASURE:** Each

ITEM#	MAX ROLL HEIGHT	DIMENSIONS
ADI622	25"	25" x 17.5" x 17.5"
ADI623	37"	37" x 17.5" x 17.5"

**CORRUGATED FIBERBOARD****ROLL STORAGE**

- 12-slot storage fits rolled sheets or documents up to 3.875" in diameter
- 20-slot storage fits rolled sheets or documents up to 2.75" in diameter

**12-SLOT WOODGRAIN****ITEM #:** ADI627**DIMENSIONS:** 22" x 15" x 12"**NUMBER OF SLOTS:** 20**COLOR:** Woodgrain**CASE QUANTITY:** 1**UNIT OF MEASURE:** Each**20-SLOT WALNUT****ITEM #:** ADI628**DIMENSIONS:** 22" x 15" x 12"**NUMBER OF SLOTS:** 20**COLOR:** Walnut**CASE QUANTITY:** 1**UNIT OF MEASURE:** Each**12 SWINGING PIVOT BRACKETS****MOBILE PIVOT****BLUEPRINT STAND CENTER**

- 12 swinging pivot brackets
- Fits any size of clamps (Clamps sold separately)
- Holds up to 240 lbs
- Adjustable height from 46" to 66"
- Adjustable length from 28" to 46"
- 3" swiveling wheels with two wheel locks
- Durable solid steel construction

**DIMENSIONS:** 46" - 66" x 27" x 28.5" - 46.5"**CASE QUANTITY:** 1**UNIT OF MEASURE:** Each

ITEM#	COLOR	
ADI613	Grey	
ADI613-BLK	Black	
ADI613-BLU	Blue	
ADI613-RED	Red	
ADI613-WHI	White	



**WOODEN UPRIGHT ROLL FILE 12 OPENINGS – BLACK**

- 12-slot storage fits rolled sheets or documents up to 4” in diameter

**ITEM#:** ADI627-WBLK

**Dimensions:** 22.24” x 15.55” x 15.55”

**Each Compartment:** 2” x 9.5”

**Unit Of Measure:** Each

**Number of Slots:** 12

**Quantity:** 1

HOLDS  
**20**  
ROLLS



**WOODEN UPRIGHT ROLL FILE 20 OPENINGS – BLACK**

- 20-slot storage fits rolled sheets or documents up to 3.4” in diameter

**ITEM#:** ADI628-WBLK

**Dimensions:** 22.24” x 15.55” x 15.55”

**Each Compartment:** 3.32” x 2.52”

**Unit Of Measure:** Each



**Number of Slots:** 20



**Quantity:** 1



**MOBILE 12-CLAMP****BLUEPRINT STAND CENTER**

- Fits 12 clamps of 24", 30", or 36" (Clamps sold separately)
- Adjustable widths for hanging clamps
- Adjustable height from 32.5" to 57"
- Adjustable width from 27.5" to 47.5"
- Durable solid steel construction
- 4 swiveling wheels with 2 wheel locks
- Holds up to 240 lbs

ITEM#	COLOR	
ADI614-BLK	Black	
ADI614-BLU	Blue	



ITEM#	COLOR	
ADI614-RED	Red	
ADI614-WHI	White	





**DIMENSIONS:** 57" x 47.5" x 15"  
**CASE QUANTITY:** 1  
**UNIT OF MEASURE:** Each

**MOBILE 18-CLAMP****BLUEPRINT STAND CENTER**

- Fits 18 clamps 24", 30", 36", or 42" (Clamps sold separately)
- Heavy-gauge steel
- 4 swiveling wheels with 2 wheel locks
- Holds up to 360 lbs

ITEM#	COLOR	
ADI615	Grey	
ADI615-BLK	Black	
ADI615-BLU	Blue	

ITEM#	COLOR	
ADI615-RED	Red	
ADI615-WHI	White	



**DIMENSIONS:** 51" x 47" x 20.5"  
**CASE QUANTITY:** 1



**UNIT OF MEASURE:** Each



**DROP LIFT****BLUEPRINT WALL RACK**

- 2 brackets
- Universal - Holds any size clamp
- Accommodates up to 12 hanging clamps in a compact space
- Holds up to 240 lbs



**DIMENSIONS:** 8" x 0.75" x 11.25"  
**CASE QUANTITY:** 1  
**UNIT OF MEASURE:** Each

ITEM#	COLOR	
ADI616-BLK	Black	
ADI616-BLU	Blue	

ITEM#	COLOR	
ADI616-RED	Red	
ADI616-WHI	White	



**CLAMPS/PAPER**  
**SHOWN NOT INCLUDED.**



**PIVOT HANGER**

**BLUEPRINT WALL RACK**

- 12 swinging pivot brackets
- Fits all sizes of hanging clamps (Clamps sold separately)
- Weight capacity of up to 240 lbs
- Durable metal
- Accommodates all hanging clamp sizes



**DIMENSIONS:** 10.5" x 24" x 15.25"  
**CASE QUANTITY:** 1

**UNIT OF MEASURE:** Each

ITEM#	COLOR
ADI617	Grey
ADI617-BLK	Black

ITEM#	COLOR
ADI617-BLU	Blue
ADI617-RED	Red
ADI617-WHI	White

**CLAMPS/PAPER SHOWN NOT INCLUDED.**

**CUBICLE**

**BLUEPRINT WALL RACK**

- Fits up to 3-1/4" wide over the top of any cubicle partition
- Extends out less than 6" into the room
- Accommodates 6 hanging clamps of all sizes
- Weight capacity of up to 120 lbs



**DIMENSIONS:** 18.5" x 1.75" x 6.75"  
**CASE QUANTITY:** 1

**UNIT OF MEASURE:** Each

ITEM#	COLOR
ADI618-BLU	Blue
ADI618-GRY	Grey
ADI618-BLK	Black

ITEM#	COLOR
ADI618-RED	Red
ADI618-WHI	White

**CONVENIENTLY HANGS ON THE WALL OF ANY CUBICLE.**

**ALUMINUM**

**HANGING BLUEPRINT CLAMPS**

- Solid steel silver wing knobs
- Transparent label holders
- Compatible with Adir, Mayline, Alvin and Safco file racks



**CASE QUANTITY:** 1  
**UNIT OF MEASURE:** Each

**HOLDS 100 SHEETS OR UP TO 20 LBS.**

ADI6016 - 18 INCH

ADI6026 - 24 INCH

ADI6036 - 30 INCH

ADI6046 - 36 INCH

ADI6056 - 42 INCH

6

PACK

FOR ALL SIZES

**HANGING****CLAMP WRENCH**

- Helps clamp up to 100 sheets of full-size drawing paper
- Maximum of 1 to 1-1/2 turns to securely clamp sheets
- Fully compatible with most manufacturers such as PlanHold, Mayline, and Adir
- Blue thermal-set grip

**ITEM#:** ADI635**CASE QUANTITY:** 1**COLOR:** Blue**UNIT OF MEASURE:** Each**50 PACK****PLAN CLIPS**

- Blank white label on each clip
- Durable plastic

**ITEM#:** ADI636**COLOR:** Black**CASE QUANTITY:** 45**UNIT OF MEASURE:** Each**TRANSLUCENT****PLAN CLIPS**

- Weather-resistant carrying case
- Made of 35C PVC translucent plastic
- Transparent on both sides

**CASE QUANTITY:** 1**UNIT OF MEASURE:** Each

ITEM#	DIMENSIONS
ADIPS1836	18" x 36"
ADIPS2436	424" x 36"
ADIPS3648	48" x 36"

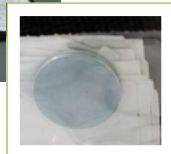

**CORNER MAGNETS HELPS FASTEN THE SHIELD TO METAL SURFACES**

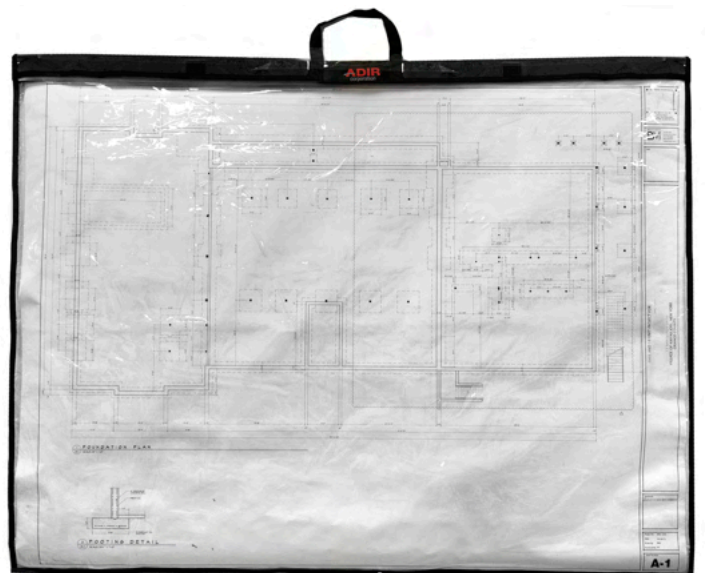

## CAR PLAN HOLDER WITH POCKETS



- Plan holder hangs on the back or front of any vehicle seat
- Slot holds up to four, 6-inch diameter plans
- Front pocket can accommodate a note pad, phone, or other small items
- Organizer strap holds pens, pencils, markers, and other necessary tools

**Item #:** ADI642

**Dimensions:** 26.5" x 15" x 0.5"

**Color:** Black

**Case Quantity:** 50

**Unit Of Measure:** Each



## BULLETIN MEMO BOARD

- Glass door offers a crystal clear view of notices
- Self-healing corkboard
- Keyed door lock
- Aluminum frames

**DIMENSIONS:** 36" x 24" x 2"

**CASE QUANTITY:** 1

**UNIT OF MEASURE:** Each



ADI504-01-BC  
BLACK/CORK



ADI504-01-BG  
BLACK/GRAY



ADI504-01-SC  
SILVER/CORK

### STURDY ALUMINUM FRAME



### KEYS INCLUDED TO LOCK GLASS PANEL



### WALL MOUNTING HARDWARE INCLUDED





# OFFICE SUPPLIES

## SUBCATEGORIES

Mail / Suggestion / Drop Boxes .....	92
Accessories and Cutting Mats .....	99
Sign Holders .....	99

**MEDIUM**

**WALL MOUNT MAIL/DROP BOX**

- Features extra 1 in. diameter opening in the middle
- Built-in storage compartment at the top behind the drop slot
- Steel construction

**DIMENSIONS:** 7.5" x 9.8" x 3.4"  
**SLOT DIMENSIONS:** 8.75" x 0.25"  
**LOCK TYPE:** Key  
**CASE QUANTITY:** 10  
**UNIT OF MEASURE:** Each



ADI631-02-WHI  
WHITE



ADI631-02-RED  
RED



ADI631-02-BLU  
BLUE



ADI631-02-BLK  
BLACK



ADI631-02-GRY  
GRAY

**LARGE**

**WALL MOUNT MAIL/DROP BOX**

- Steel Construction

**DIMENSIONS:** 10" x 12" x 3"  
**SLOT DIMENSIONS:** 10" x 5/16"  
**LOCK TYPE:** Key

**CASE QUANTITY:** 10  
**UNIT OF MEASURE:** Each



ITEM#	COLOR	
ADI631-03	Gray	
ADI631-03-BLK	Black	
ADI631-03-BLU	Blue	
ADI631-03-RED	Red	
ADI631-03-WHI	White	

**OUTDOOR**

**WALL MOUNT MAIL/DROP BOX**

- Flip-up, slanted lid for a roof-like cover
- Dual drop design
- Designed for both indoor and outdoor use
- Steel construction

**DIMENSIONS:** 9.7" x 5.5" x 3"  
**SLOT DIMENSIONS:** 2" x 2" / 4.25" x 0.25"  
**LOCK TYPE:** Key  
**CASE QUANTITY:** 10  
**UNIT OF MEASURE:** Each



ITEM#	COLOR	
ADI631-11-BLK	Black	
ADI631-11-BLU	Blue	
ADI631-11-RED	Red	
ADI631-11-WHI	White	



**LARGE**  
**KEY DROP BOX**

- Suitable for indoor use or outside in sheltered areas
- Dual drop design
- Steel construction

**DIMENSIONS:** 9.5" x 5.5" x 3"  
**SLOT DIMENSIONS:** 2" x 2" / 4.25" x 0.25"  
**LOCK TYPE:** Key  
**CASE QUANTITY:** 10  
**UNIT OF MEASURE:** Each

ITEM#	COLOR	
ADI631-12-BLK	Black	
ADI631-12-BLU	Blue	
ADI631-12-RED	Red	
ADI631-12-WHI	White	

**MEDIUM - KEY LOCK**



**MEDIUM - KEY/COMBO LOCK**



**LARGE - KEY LOCK**



**LARGE - KEY/COMBO LOCK**



**HEAVY-DUTY**

**WALL MOUNT MAIL/DROP BOX**

- Constructed of 16-Gauge galvanized steel
- Powder-coated, scratch-resistant finish
- Commercial grade 12-disc wafer lock

**UNIT OF MEASURE:** Each

ITEM#	COLOR	SIZE	SIZE	SLOT DIMENSIONS	DOOR DIMENSIONS	UNIT DIMENSIONS	LOCK TYPE	CASE QTY.
ADI631-05-BLK	Black		Medium	9.2" x 2"	8.25" x 9.5"	12.2" x 10.5" x 4.7"	Key	5
ADI631-05-BLU	Blue		Medium	9.2" x 2"	8.25" x 9.5"	12.2" x 10.5" x 4.7"	Key	5
ADI631-05-RED	Red		Medium	9.2" x 2"	8.25" x 9.5"	12.2" x 10.5" x 4.7"	Key	5
ADI631-05-WHI	White		Medium	9.2" x 2"	8.25" x 9.5"	12.2" x 10.5" x 4.7"	Key	5
ADI631-05-BLK-KC	Black		Medium	9.2" x 2"	8.25" x 9.5"	12.2" x 10.5" x 4.7"	Key/Combo	5
ADI631-05-BLU-KC	Blue		Medium	9.2" x 2"	8.25" x 9.5"	12.2" x 10.5" x 4.7"	Key/Combo	5
ADI631-05-WHI-KC	White		Medium	9.2" x 2"	8.25" x 9.5"	12.2" x 10.5" x 4.7"	Key/Combo	5
ADI631-04-BLK	Black		Large	10" x 2.75"	11.5" x 10"	16.2" x 11.2" x 4.7"	Key	4
ADI631-04-BLU	Blue		Large	10" x 2.75"	11.5" x 10"	16.2" x 11.2" x 4.7"	Key	4
ADI631-04-RED	Red		Large	10" x 2.75"	11.5" x 10"	16.2" x 11.2" x 4.7"	Key	4
ADI631-04-WHI	White		Large	10" x 2.75"	11.5" x 10"	16.2" x 11.2" x 4.7"	Key	4
ADI631-04-BLK-KC	Black		Large	10" x 2.75"	11.5" x 10"	16.2" x 11.2" x 4.7"	Key/Combo	4
ADI631-04-BLU-KC	Blue		Large	10" x 2.75"	11.5" x 10"	16.2" x 11.2" x 4.7"	Key/Combo	4
ADI631-04-WHI-KC	White		Large	10" x 2.75"	11.5" x 10"	16.2" x 11.2" x 4.7"	Key/Combo	4



ADI631-13-BLK  
BLACK



ADI631-13-WHI  
WHITE

## DOCUMENT

### WALL MOUNT MAIL/DROP BOX

- Generous storage capacity accessed by a 7.5" x 6.75" door
- Heavy-gauge welded steel construction

**DIMENSIONS:** 16.3" x 10" x 4"

**SLOT DIMENSIONS:** 8" x 0.5"

**LOCK TYPE:** Key

**CASE QUANTITY:** 1

**UNIT OF MEASURE:** Each

## SPACE-SAVER DOCUMENT

### WALL MOUNT MAIL/DROP BOX

- Readily accepts legal-sized documents and other important correspondence
- Steel construction

**DIMENSIONS:** 16" x 11" x 2.4"

**SLOT DIMENSIONS:** 9" x 0.4"

**LOCK TYPE:** Key

**CASE QUANTITY:** 1

**UNIT OF MEASURE:** Each



ADI631-14-BLK  
BLACK



ADI631-14-WHI  
WHITE







ADI631-07-BLK  
BLACK



ADI631-07-WHI  
WHITE

**14 POUND, HEAVY-DUTY  
WALL MOUNT MAIL/DROP BOX**

- Collection door provides easy access
- Heavy-duty steel construction
- Pick resistant lock
- Double D cam lock

**DIMENSIONS:** 15" x 12" x 4"  
**SLOT DIMENSIONS:** 9.8" x 2.3"  
**DOOR DIMENSIONS:** 5.8" x 9.8"

**LOCK TYPE:** Key  
**CASE QUANTITY:** 1  
**UNIT OF MEASURE:** Each

**THROUGH-THE-WALL  
MAIL/DROP BOX**

- Min. wall thickness chute will accommodate 3.25" depth
- Max. wall thickness chute will accommodate 7.75" depth
- Adjustable in-wall or door chute 3.25" - 7.75" deep
- Anti-fishing metal baffle
- Pick resistant lock
- Lock type: Key
- Piano-hinged door



**DIMENSIONS:** 16" x 12" x 6"  
**SLOT DIMENSIONS:** 8.5" x 1"  
**DOOR DIMENSIONS:** 5.8" x 9.8"  
**CASE QUANTITY:** 1  
**UNIT OF MEASURE:** Each



ITEM#	COLOR
ADI631-10-BLK	Black 

ITEM#	COLOR
ADI631-10-GRY	Gray 

ITEM#	COLOR
ADI631-10-WHI	White 

**THROUGH-THE-DOOR  
MAIL/DROP BOX**

- Mount through doors
- Anti-fishing metal baffle
- Double D cam lock
- Heavy-duty steel construction
- Pick resistant lock
- Hardware included

**ITEM#:** ADI631-06-BLK  
**DIMENSIONS:** 15" x 12" x 6"  
**SLOT DIMENSIONS:** 9.8" x 2.3"  
**LOCK TYPE:** Key

**ITEM#:** ADI631-06-WHI  
**CASE QUANTITY:** 1  
**UNIT OF MEASURE:** Each



ADI631-06-BLK  
BLACK



ADI631-06-WHI  
BLACK









**STEEL**

**SUGGESTION BOX**

- Features extra 1” diameter opening in the middle
- Front pocket to hold cards, pens, small envelopes
- 25 suggestions cards and adhesive labels included
- Steel construction
- Place on any flat surface or mount on a wall

**DIMENSIONS:** 8.5” x 7” x 6”  
**SLOT DIMENSIONS:** 4.75” x 0.125”  
**LOCK TYPE:** Key  
**CASE QUANTITY:** 10  
**UNIT OF MEASURE:** Each

ITEM#	COLOR
ADI631-01-BLK	Black 
ADI631-01-BLU	Blue 
ADI631-01-RED	Red 
ADI631-01-WHI	White 

**INCLUDED WITH SUGGESTION BOXES:**

- Labels
- Suggestion cards
- Extra keys
- Wall mounting hardware





**RUSTIC WOOD**

**SUGGESTION BOX**

- Features extra 1” diameter opening in the middle
- Place on any flat surface or mount on a wall
- Front pocket to hold cards, pens, small envelopes, etc.
- Locking hinged lid keeps ballots protected

**DIMENSIONS:** 9” x 8” x 7”    **CASE QUANTITY:** 8  
**LOCK TYPE:** Key                    **UNIT OF MEASURE:** Each

ITEM#	COLOR
ADI632-02-BLK	Black 
ADI632-02-BRW	Brown 
ADI632-02-WHI	White 







**WOOD**

**SUGGESTION BOX**

- Features extra 1” diameter opening in the middle
- Pen with chain and adhesive mount included
- Place on any flat surface or mount on a wall
- Side pocket conveniently holds entry forms
- Locking hinged lid keeps ballots protected

**DIMENSIONS:** 10” x 7.25” x 7.5”  
**LOCK TYPE:** Key  
**CASE QUANTITY:** 8  
**UNIT OF MEASURE:** Each

ITEM#	COLOR
ADI632-01-BLK	Black 
ADI632-01-BLU	Blue 
ADI632-01-MA	Mahogany 
ADI632-01-MEO	Medium Oak 



ADI632

**CUSTOMIZABLE WOOD  
SUGGESTION BOX**

- Customizable plexiglass message display window
- 25 suggestions cards included
- 2-carved-in holes to store pens, as well as a slot for holding suggestion cards
- Place on any flat surface or mount on a wall

**DIMENSIONS:** 14" x 10.5" x 5.3"  
**LOCK TYPE:** Key  
**CASE QUANTITY:** 8  
**UNIT OF MEASURE:** Each

ITEM#	COLOR	ITEM#	COLOR	ITEM#	COLOR
ADI632	Mahogany	ADI632-BLU	Blue	ADI632-RED	Red
ADI632-BLK	Black	ADI632-GRN	Green	ADI632-YEL	Yellow

**ACRYLIC  
SUGGESTION/DONATION BOX**

- Rear door allows easy authorized access to contents
- Secure lock on the rear door ensures that the contents inside are safe and secure
- Key lock
- Durable, shatter-resistant acrylic construction

**SLOT DIMENSIONS:** 14" x 10.5" x 5.3"  
**LOCK TYPE:** Key  
**CASE QUANTITY:** 1  
**UNIT OF MEASURE:** Each

ITEM#	COLOR	DIMENSIONS
ADI637-02-4	Clear	12" x 12" x 12"
ADI637-02-4-BLK	Black	12" x 12" x 12"



**TALL ACRYLIC  
SUGGESTION/DONATION BOX  
WITH MESSAGE DISPLAY**

- Durable, shatter-resistant acrylic construction
- Customizable message display board
- Sturdy lock with a set of 2 keys
- Key lock

**ITEM#:** ADI637-04-CLR  
**UNIT DIMENSIONS:** 8.5" x 6.75" x 5"  
**SLOT DIMENSIONS:** 4" x 0.5"











**LOCK TYPE:** Key  
**CASE QUANTITY:** 8  
**UNIT OF MEASURE:** Each



**ACRYLIC****SUGGESTION/DONATION BOX****WITH MESSAGE DISPLAY**

- Customizable message display board
- Sturdy lock with a set of 2 keys
- Key lock
- Durable, shatter-resistant acrylic construction

**UNIT DIMENSIONS:** 4.5" x 6.2" x 4"**SLOT DIMENSIONS:** 4" x 0.5"**LOCK TYPE:** Key**CASE QUANTITY:** 8**UNIT OF MEASURE:** Each

ITEM#	COLOR	
ADIOF637-BLK	Black	
ADIOF637-CRG	Crystal Green	
ADIOF637-GRN	Green	
ADIOF637-PNK	Pink	
ADIOF637-RED	Red	
ADIOF637-YLK	Yellow	
ADIOF637-BLU	Blue	
ADIOF637-CRB	Clear Blue	
ADIOF637-CRR	Clear Red	
ADIOF637-PUR	Purple	

**ADIOF637- CRG****ADIOF637- BLK****ADIOF637- RED****ADIOF637- PNK****ADIOF637- YLK****ADIOF637- GRN**

**SELF-HEALING**

**REVERSIBLE CUTTING MATS**

- Extremely durable, 3 mm thickness
- 3-ply design with self-healing surface and hard core making it usable on both sides
- Non-slip for added safety on work tables
- Calibrated grid lines for easy cutting references
- Non-glare cutting surface

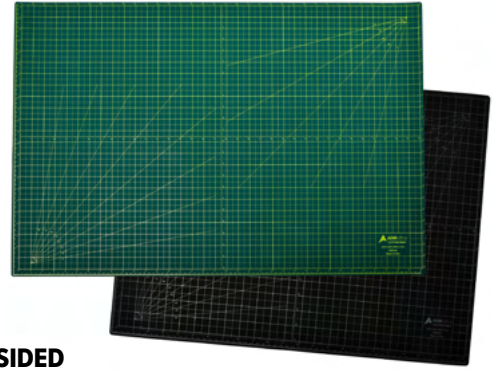

**UNIT OF MEASURE:** Each

ITEM#	DIMENSIONS	COLOR	CASE QTY.
ADICM1218	12" X 18"	Green/Black	24
ADICM1824	18" x 24"	Green/Black	12
ADICM1836	18" x 36"	Green/Black	20

**DOUBLE-SIDED**

ITEM#	DIMENSIONS	COLOR	CASE QTY.
ADICM2436	24" x 36"	Green/Black	6
ADICM3042	30" x 42"	Green/Black	4
ADICM3648	36" x 48"	Green/Black	3

**SUGGESTION BOX CARDS**

- Perfect match to any suggestion box
- Lined for neat comments
- Three labeled sections



**25**  
PACK

**ITEM #:** ADI633  
**DIMENSIONS:** 8.5" x 4" x 0.10"  
**CASE QUANTITY:** 1  
**UNIT OF MEASURE:** Pack



**50**  
PACK

**ITEM #:** ADI633-50  
**DIMENSIONS:** 8.5" x 4" x 0.10"  
**CASE QUANTITY:** 1  
**UNIT OF MEASURE:** Pack

OFFICE SUPPLIES / SIGN HOLDERS

**8.5" X 11"**

**SIGN HOLDERS**

- Double-sided viewing
- Durable, shatter-resistant acrylic construction

**UNIT OF MEASURE:** Each

ITEM#	DESCRIPTION	UNIT OF MEASURE
ADI639-8511-06	Slanted Side-Loading	6 Pack
ADI639-8511-12	Slanted Side-Loading	12 Pack
ADI639-8511-36	Slanted Side-Loading	36 Pack
ADI639-8511-6-TL	Upright Frame Top Loading	6 Pack
ADI639-8511-6-WM	Wall Mount	6 Pack
ADI639-8511-12-WM	Wall Mount	12 Pack
ADI639-8511-WSH-2	Window Sign Holder with Suction Cups	2 Pack
ADI639-8511-WSH-6	Window Sign Holder with Suction Cups	6 Pack
ADI639-8511-WSH-12	Window Sign Holder with Suction Cups	12 Pack
ADI639-8555-WSH-2	Window Sign Holder with Suction Cups - Horizontal	2 Pack



SLANTED SIDE-LOADING



T-SHAPED BASE



UPRIGHT FRAME TOP LOADING



WALL MOUNTABLE



WINDOW HOLDER WITH SUCTION CUPS - VERTICAL



WINDOW HOLDER WITH SUCTION CUPS - HORIZONTAL

# CONTACT INFORMATION



Monday - Thursday: 9:00am - 5:30pm est / Friday: 9:00am - 3:00pm est



1.800.805.1790



[info@alpineindustries.com](mailto:info@alpineindustries.com)



© 2022 Alpine Industries. All Rights Reserved.